

CC2530 With Skyworks' SE2431L Range Extender Front End

Farrukh Inam and Shiou Mei Huang

ABSTRACT

This application report describes the expected performance of the CC2530 and the SE2431L module. The combined CC2530 and SE2431L solution is suitable for systems targeting compliance with FCC CFR47 Part 15.

The RF front end of CC2530 has the same settings as the ones being used in CC2531. Therefore, the presented results are also valid for CC2531.

Contents

1	Introduction	2
2	Absolute Maximum Ratings	2
3	Electrical Specifications	2
4	Application Circuit	9
5	Regulatory Requirements	10
6	PCB Layout Considerations	11
7	Controlling the SE2431L	12
8	Configuring the Combo With SmartRF Studio and SmartRF05EB Board	13
9	References	15

List of Figures

1	TX Power vs. Frequency and V_{DD} , TXPOWER = 0xF5	5
2	RX LNA Mode Sensitivity vs. Frequency and V_{DD}	5
3	Rx Bypass Mode Sensitivity vs. Frequency and V_{DD}	6
4	Selectivity Operating at Channel 18 (2440 MHz)	6
5	RSSI Readout vs. Input Power.....	7
6	Conducted Power Spectral Density, TXPOWER = 0xF5	8
7	Application Circuit for the CC2530 With SE2431L	9
8	Conducted Spurious Emission vs. FCC Part 15.247 Limit (TXPOWER = 0xE5, RBW = 1 MHz, VBW = 10 Hz)	10
9	Conducted Spurious Emission, Lower Band Edge (TXPOWER = 0xE5, RBW = 1 MHz, VBW = 10 Hz)	11
10	Conducted Spurious Emission, Upper Band Edge (TXPOWER = 0xE5, RBW = 1 MHz (100 kHz), VBW = 10 Hz)	11
11	CC2530-SE2431L Interconnect	13
12	CC2530-SE2431L Interconnect Register Settings	14

List of Tables

1	Abbreviations	2
2	Operating Conditions	3
3	Current Consumption	3
4	Receive Parameters	3

ZigBee is a registered trademark of ZigBee Alliance.
 All other trademarks are the property of their respective owners.

5	RSSI Compensation	3
6	Transmit Parameters	4
7	Power Table	4
8	Transmit PSD Limits.....	7
9	Control Logic for Connecting the SE2431L to a CC2530 Device	12

1 Introduction

The CC2530 is TI's second generation ZigBee® IEEE 802.15.4 RF System-on-Chip (SoC) for the 2.4 GHz unlicensed ISM band. This chip enables industrial grade applications by offering state-of-the-art selectivity and co-existence, excellent link budget, and low voltage operation.

The SE2431L is a high-performance, fully integrated RF Front-End Module (FEM) that is designed for ZigBee/Smart Energy and 802.15.4 applications. The SE2431L is designed for ease-of-use and maximum flexibility, with fully matched 50 Ω input and output, and integrated inter-stage matching and harmonic filter, and digital controls that are compatible with 1.6 V to 3.6 V CMOS levels. The RF blocks operate over a wide supply voltage range from 2.2 V to 3.6 V, which allows the SE2431L to be used in battery-powered applications over a wide spectrum of the battery discharge curve.

Table 1. Abbreviations

SoC	System-on-Chip
DSSS	Direct Sequence Spread Spectrum
EM	Evaluation Module
EVM	Error Vector Magnitude
ISM	Industrial, Scientific, Medical
FCC	Federal Communications Commission
FHSS	Frequency Hopping Spread Spectrum
LNA	Low Noise Amplifier
PA	Power Amplifier
PCB	Printed Circuit Board
PSD	Power Spectral Density
RF	Radio Frequency
RSSI	Receive Signal Strength Indicator
RX	Receive, Receive Mode
TX	Transmit, Transmit Mode
VSWR	Voltage Standing Wave Ratio

2 Absolute Maximum Ratings

The absolute maximum ratings and operating conditions listed in *CC2530F32, CC2530F64, CC2530F128, CC2530F256 A True System-on-Chip Solution for 2.4-GHz IEEE 802.15.4 and ZigBee Applications (SWRS081)* and the *SE2431L: 2.4 GHz ZigBee®/802.15.4 Front-End Module (http://www.skyworksinc.com/uploads/documents/SE2431L_202410D.pdf)* must be followed at all times. Stress exceeding one or more of these limiting values may cause permanent damage to any of the devices.

3 Electrical Specifications

Note that these characteristics are only valid when using the recommended register settings presented in [Section 3.6](#).

3.1 Operating Conditions

Table 2. Operating Conditions

Parameter	Min	Max	Unit
Operating Frequency	2400	2485	MHz
Operating Supply Voltage	2.2	3.6	V
Operating Temperature	-	25	°C

3.2 Receive Current Consumption

$T_C = 25^\circ\text{C}$, $V_{DD} = 3.0\text{ V}$ and $f = 2440\text{ MHz}$ if nothing else is stated. All parameters are measured on the CC2530 – SE2431L design [10] with a 50 Ω load.

Table 3. Current Consumption

Parameter	Condition	Typical	Unit
Receive Current	-90 dBm input level	29	mA
	-50 dBm input level	29	

3.3 Receive Parameters

$T_C = 25^\circ\text{C}$, $V_{DD} = 3.0\text{ V}$ and $f = 2440\text{ MHz}$ if nothing else is stated. All parameters are measured on the CC2530 – SE2431L design [10] with a 50 Ω load.

Table 4. Receive Parameters

Parameter	Condition	Typical	Unit
Receive Sensitivity - RX LNA Mode	1 % PER, IEEE 802.15.4 [6] requires -85 dBm	-101.8	dBm
Receive Sensitivity - RX Bypass Mode	1 % PER, IEEE 802.15.4 [6] requires -85 dBm	-94.1	dBm
Saturation	IEEE 802.15.4 [7] requires -20 dBm	> 5.5	dBm
Interferer Rejection	Wanted signal 3 dB above the sensitivity level, IEEE 802.15.4 modulated interferer at IEEE 802.15.4 channels		
	$\pm 5\text{ MHz}$ from wanted signal, IEEE 802.15.4 [7] requires 0 dB	33	dB
	$\pm 10\text{ MHz}$ from wanted signal, IEEE 802.15.4 [7] requires 30 dB	48	dB
	$\pm 20\text{ MHz}$ from wanted signal. Wanted signal at -82 dBm	48	dB

3.4 Received Signal Strength Indicator (RSSI)

Due to in the external LNA and the offset in CC2530 the RSSI readouts from CC2530 – SE2431L is different from RSSI offset values for a standalone CC2530 design. The offset values are shown in Table 5.

Table 5. RSSI Compensation

CC2530-SE2431L	RSSI Offset ⁽¹⁾
LNA Mode	85 dB

⁽¹⁾ Real RSSI = Register value – RSSI offset

3.5 Transmit Parameters

$T_C = 25^\circ\text{C}$, $V_{DD} = 3.0\text{ V}$ and $f = 2440\text{ MHz}$ if nothing else is stated. All parameters are measured on the CC2530 – SE2431L design with a $50\ \Omega$ load.

Table 6. Transmit Parameters

Parameter	Condition	Typical	Unit
Radiated Emission with TXPOWER = 0xF5	Conducted 2 RF (FCC restricted band)	-63.7	dBm
	Conducted 3 RF (FCC restricted band)	-74.7	

3.6 Output Power Programming and Transmit Current Consumption

The RF output power of the CC2530 – SE2431L module is controlled by the 7-bit value in the CC2530 TXPOWER register. [Table 7](#) shows the typical output power and current consumption for the recommended power settings. The results are given for $T_C = 25^\circ\text{C}$, $V_{DD} = 3.0\text{ V}$ and $f = 2440\text{ MHz}$, and are measured on the CC2530 – SE2431L reference design [10] with a $50\ \Omega$ load.

Table 7. Power Table ⁽¹⁾

TXPOWER	Power [dBm]	Current [mA]
0xF5	21.5	195
0xE5	21.1	170.3
0xD5	20.5	151
0xC5	19.7	137
0xB5	18.8	124.6
0xA5	17.4	110.3
0x95	15.5	95.6
0x85	14.2	88
0x75	12.3	79.3
0x65	10.6	72

⁽¹⁾ Output power higher than 20 dBm will require a 4th or 5th order antenna filter.

Note that the recommended power settings given in [Table 7](#) are a subset of all the possible TXPOWER register settings. However, using other settings than those recommended might result in suboptimal performance in areas like current consumption, and spurious emission.

3.7 Typical RF Performance Curves

$T_C = 25^\circ\text{C}$, $V_{DD} = 3.0\text{ V}$ and $f = 2440\text{ MHz}$ if nothing else is stated. All parameters are measured on the CC2530 – SE2431L EM reference design [10] with a $50\ \Omega$ load.

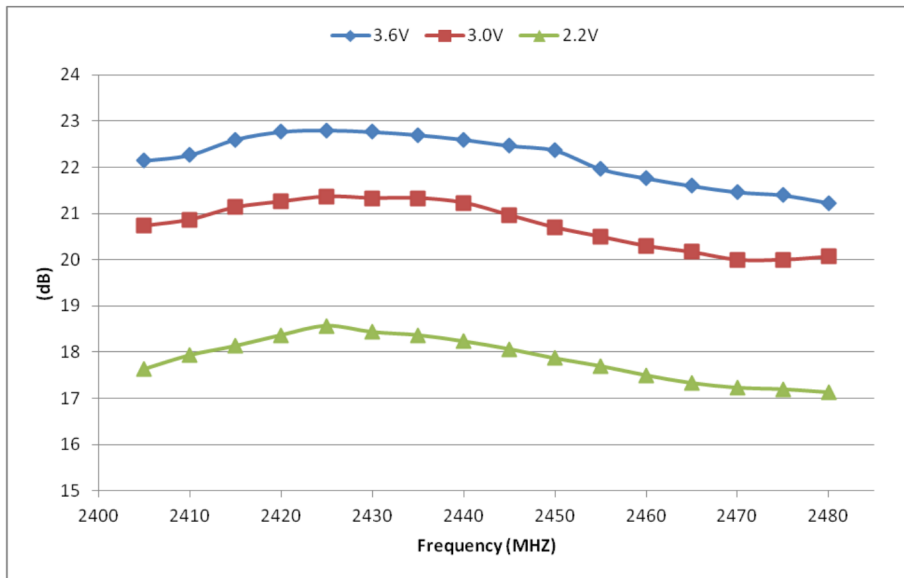

Figure 1. TX Power vs. Frequency and V_{DD} , TXPOWER = 0xF5

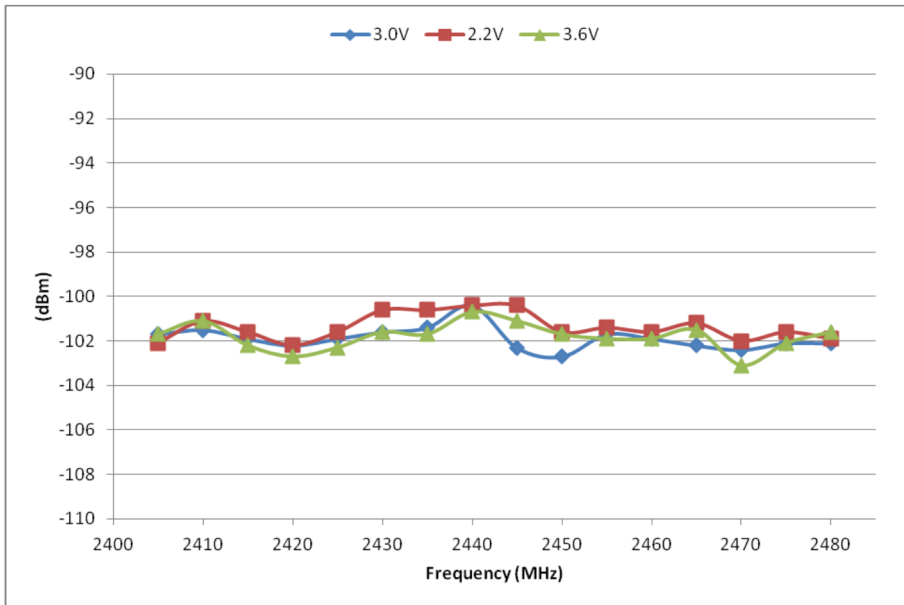

Figure 2. RX LNA Mode Sensitivity vs. Frequency and V_{DD}

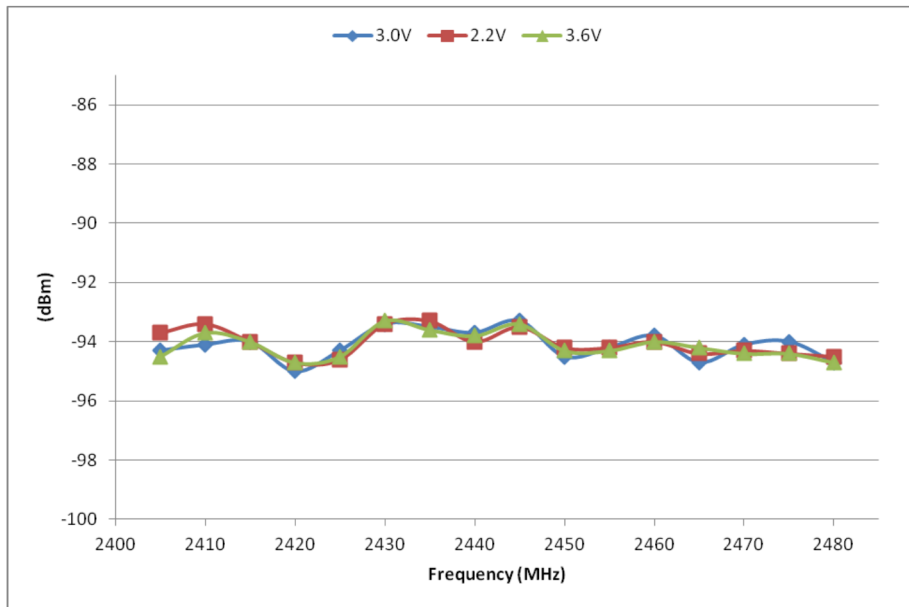

Figure 3. Rx Bypass Mode Sensitivity vs. Frequency and V_{DD}

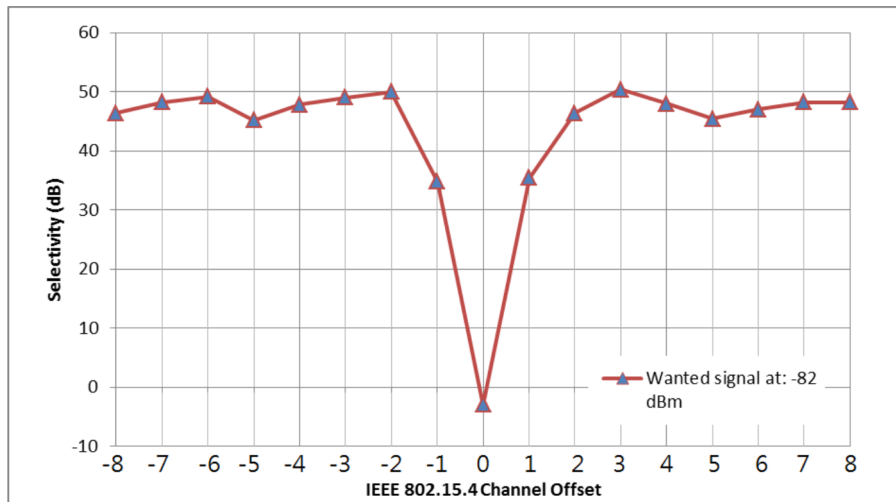

Figure 4. Selectivity Operating at Channel 18 (2440 MHz)

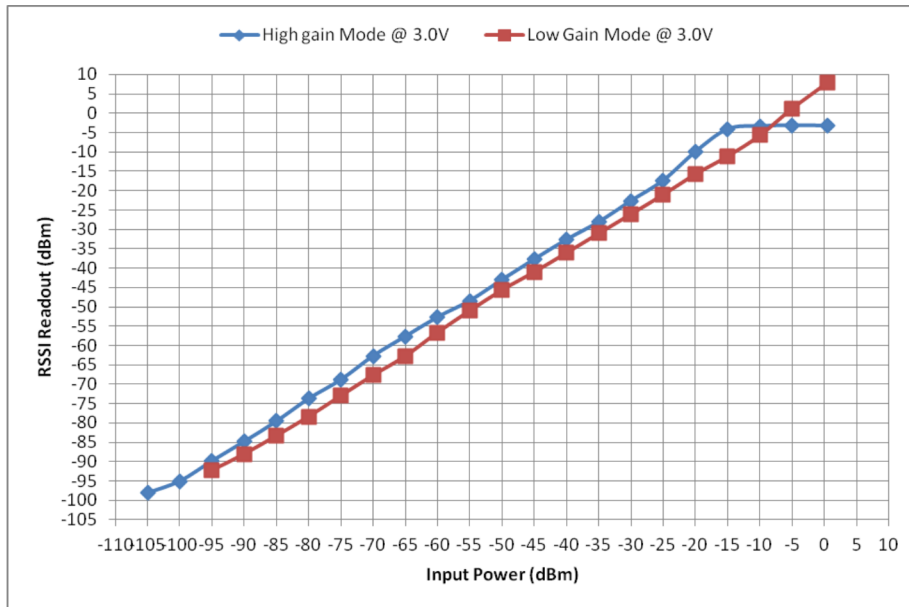

Figure 5. RSSI Readout vs. Input Power

3.8 IEEE - Transmit Power Spectral Density (PSD) Mask

The IEEE standard 802.15.4 [7] requires the transmitted spectral power to be less than the limits specified in Table 8.

Table 8. Transmit PSD Limits

Frequency	Relative Limit	Absolute Limit
$ f - fc > 3.5 \text{ MHz}$	-20 dB	-30 dBm

The results shown in [Figure 6](#) are given for $T_C = 25^\circ\text{C}$, $V_{DD} = 3.0\text{ V}$ and $f = 2440\text{ MHz}$, and are measured on the CC2530 – SE2431L reference design [\[10\]](#) with a $50\ \Omega$ load.

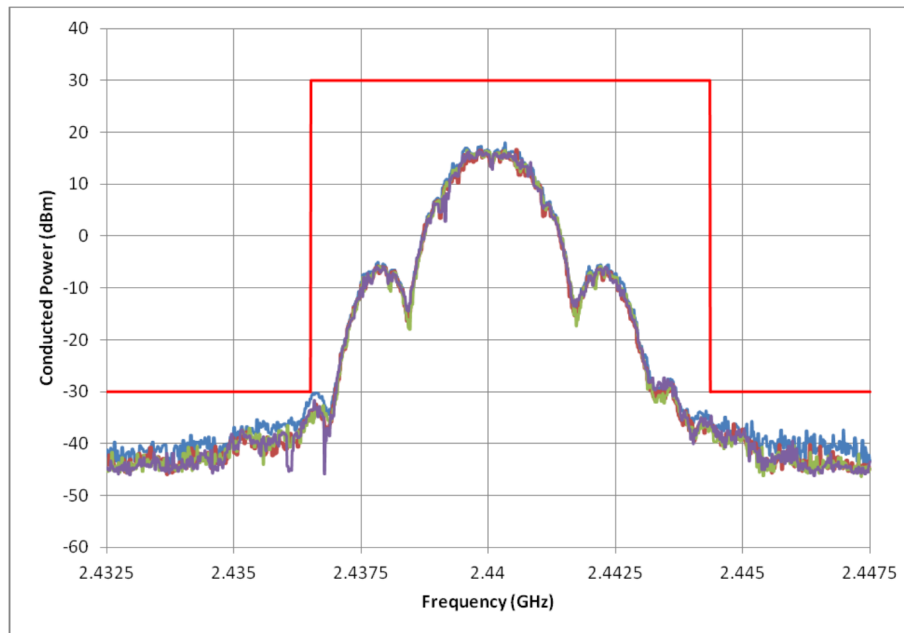

Figure 6. Conducted Power Spectral Density, TXPOWER = 0xF5

4 Application Circuit

A typical application circuit is shown in Figure 7. Note that the application circuit figure does not show how the board layout should be done. The board layout greatly influences the RF performance of the CC2530 – SE2431L module. TI provides a compact CC2530 – SE2431L reference design [10] that it is highly recommended to follow. The layout, stack-up and schematic for the SE2431L need to be copied exactly to obtain good performance. Note that the reference design also includes bill of materials with manufacturer part numbers.

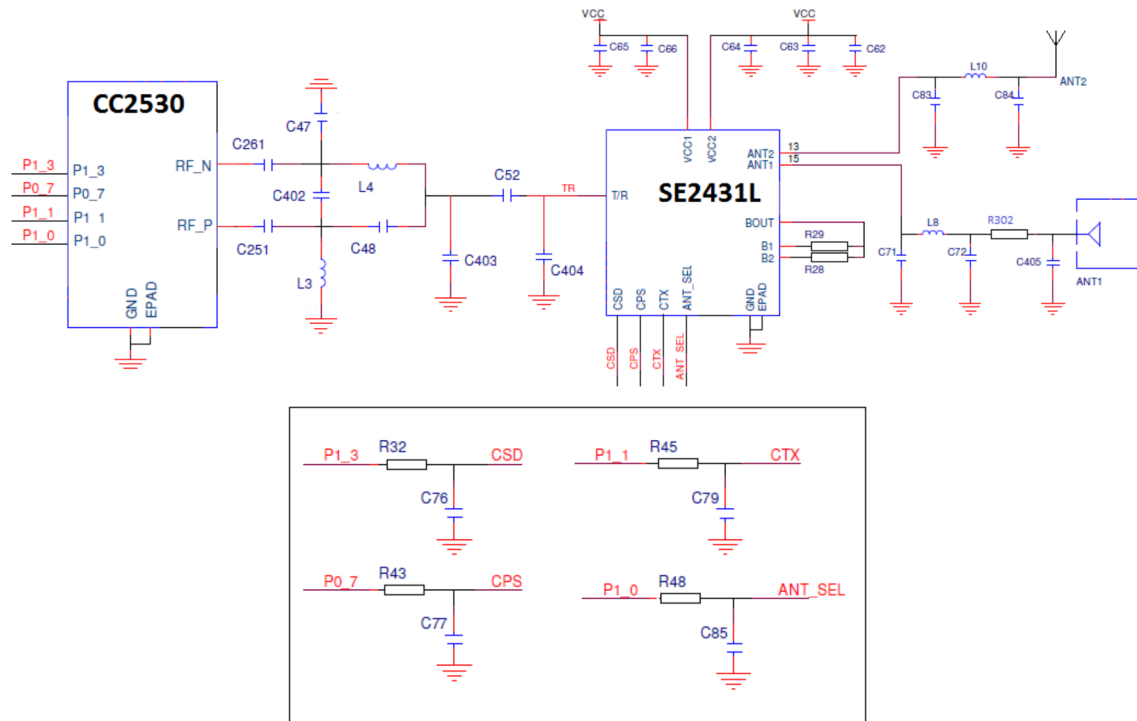

Figure 7. Application Circuit for the CC2530 With SE2431L

4.1 Power Decoupling and RF Loading

Proper power supply decoupling must be used for optimum performance. In Figure 7, only the decoupling components for the SE2431L are shown.

The placement and size of the decoupling components, the power supply filtering and the PCB transmission line dimensions are also important in achieving the best performance. Details about the importance of copying the CC2530 – SE2431L EM reference design exactly and potential consequences of changes are explained in Section 6.

4.2 Input/Output Matching and Filtering

The RF input/output of CC2530 is high impedance and differential. A balun circuit is added between CC2530 and SE2431L to optimize performance and enable RF matching.

Note that the PCB transmission lines that connect the two devices also are part of the RF matching.

The network between the SE2431L and the antenna or SMA matches the SE2431L to a 50 Ω load and provides filtering to pass regulatory demands. A DC block is not required. R302 and C405 are provided as place holders for tuning antenna match.

4.3 Bias Resistor

Bias resistors, R29 and R28 are used to set an accurate bias current for internal use in the SE2431L.

4.4 Antenna Considerations

In the reference design, one output is connected to the antenna through a filter L8, C71, and C72 and antenna tuning components R302 and L11 and the other to an SMA connector through a filter L10, C83 and C84. The RF output can be switched between the two ports by controlling the ANT_SEL pin of SE2431L. Note that all testing and characterization has been done using the SMA connector. The PCB antenna has only been functionally tested by establishing a link between two EMs. For further details on the antenna solutions, see [5] and [6].

5 Regulatory Requirements

The Federal Communications Commission (FCC) CFR 47, Part 15, regulates RF products intended for use in the unlicensed band. A product intended for unlicensed operation must be tested for compliance and if approved is issued an identification number.

The specific frequency bands used for unlicensed radio equipment for the 2.4 GHz band are regulated by section 15.247 and 15.249. General rules for certification measurements are found in section 15.35. Restricted bands and general limits for spurious emissions are found in sections 15.205 and 15.209.

5.1 Band Edge Spectrum Measurements

When using CC2530 with the SE2431L, duty cycling or back-off is only needed for highest IEEE 802.15.4 channel (channel 26) to comply with FCC at maximum recommended output power (TXPOWER = 0xE5). The real required duty cycling or back-off may be different for applications with different antennas, plastic covers, or other factors that amplify or attenuate the radiated power therefore the tests on the final product should be made for compliance.

Figure 8 shows the level of the conducted spurious emission and margins to the FCC Part 15.247 limits for the IEEE 802.15.4 channels under typical conditions (TC = 25°C, $V_{DD} = 3.0$ V) when transmitting at TXPOWER = 0xE5 using the CC2530 - SE2431LEM [10]. Figure 9 and Figure 10 show the margins versus the FCC 15.247 for the lowest frequency channels at the lower band edge and for the upper frequency channels at the upper band edge, respectively.

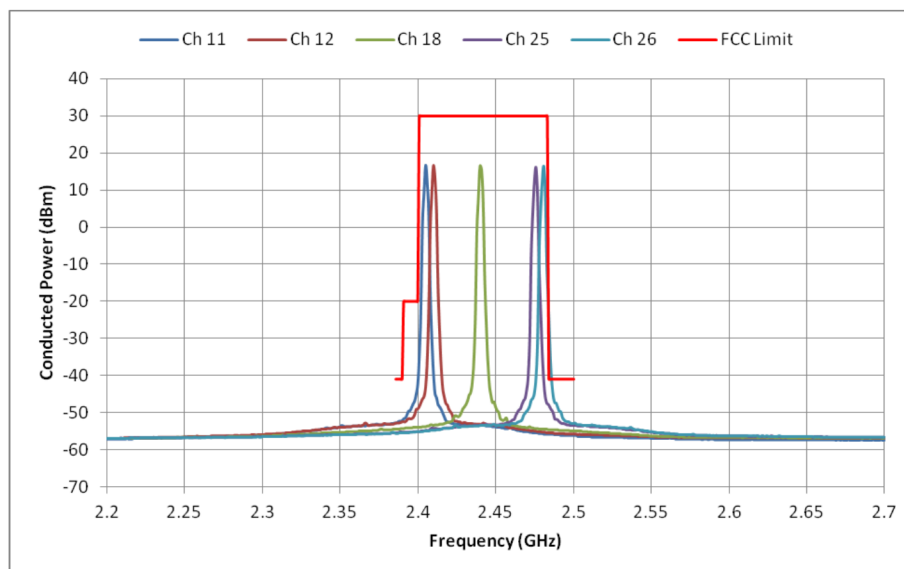

Figure 8. Conducted Spurious Emission vs. FCC Part 15.247 Limit (TXPOWER = 0xE5, RBW = 1 MHz, VBW = 10 Hz)

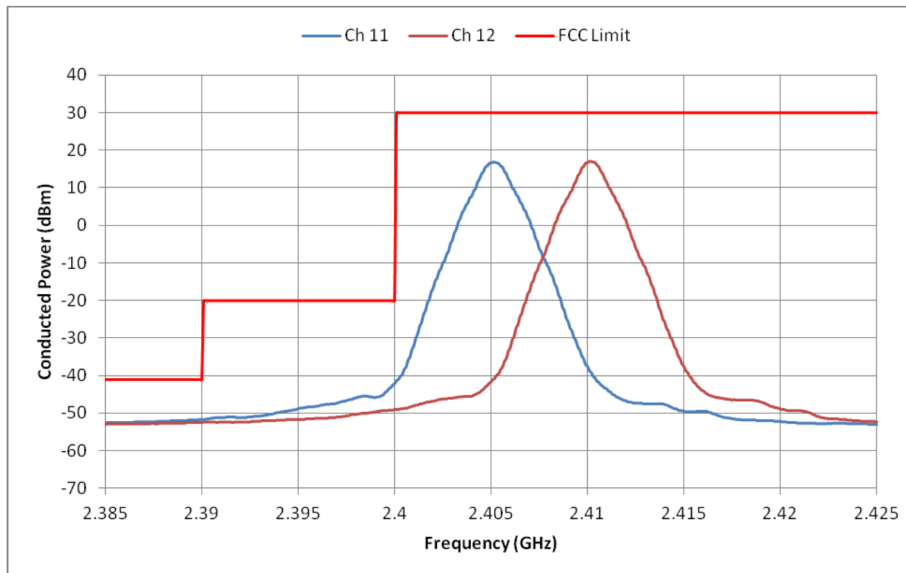

Figure 9. Conducted Spurious Emission, Lower Band Edge (TXPOWER = 0xE5, RBW = 1 MHz, VBW = 10 Hz)

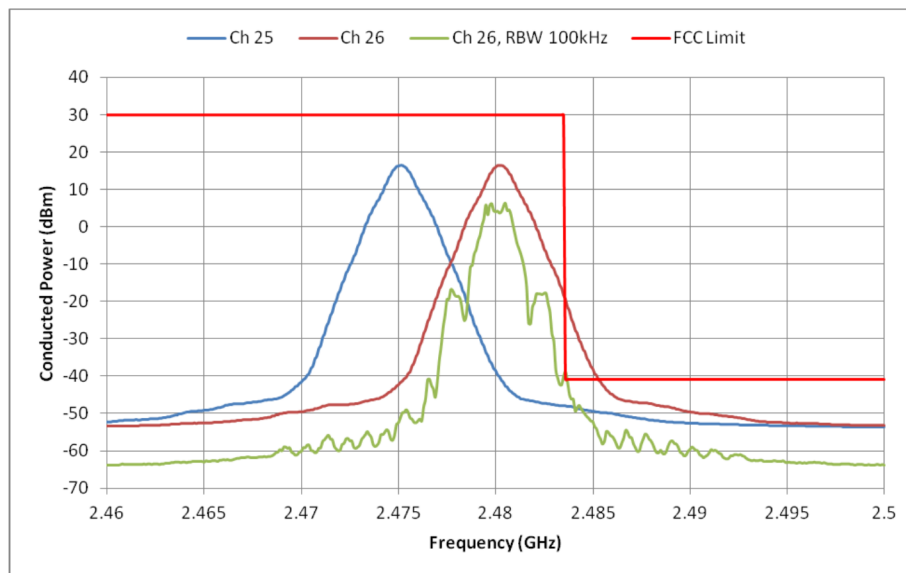

Figure 10. Conducted Spurious Emission, Upper Band Edge (TXPOWER = 0xE5, RBW = 1 MHz (100 kHz), VBW = 10 Hz)

6 PCB Layout Considerations

The Texas Instruments reference design uses a 0.0634 inch, 4-layer PCB solution. Note that the different layers have different thickness; it is important to follow the recommendation given in the CC2530 - SE2431LEM reference design [10] to ensure optimum performance.

The top layer is used for components and signal routing, and the open areas are filled with metallization connected to ground using several vias. The areas under the two chips are used for grounding and must be well connected to the ground plane with multiple vias. The footprint recommendation for the SE2431L is given in [3].

Layer two is a complete ground plane and is not used for any routing. This is done to ensure short return current paths. The low impedance of the ground plane prevents any unwanted signal coupling between any of the nodes that are decoupled to it. A dedicated ground plane is also needed to improve stability (see [Section 6.1](#)). Layer three is a power plane. The power plane ensures low impedance traces at radio frequencies and prevents unwanted radiation from power traces. Layer four is used for routing, and as for layer one, open areas are filled with metallization connected to ground using several vias.

6.1 CC2530 – SE2431L Stability

When a common, center ground-pin and paddle is used, all inductance seen between this ground paddle and the ground plane gives rise to feedback. This feedback might give rise to oscillations. It is difficult to say exactly how much inductance is present between the ground paddle and the ground plane: it depends on the chip design. Still, a general rule of thumb is that chances of oscillations increase when the RF currents increase. Therefore, it is desirable to use a 4-layer PCB with a ground-plane close to the top layer of the CC2530 - SE2431LEM reference design [\[10\]](#).

6.2 The Gain of SE2431L

Changing the layout or the stack-up of the reference design [\[10\]](#) may affect the gain of the SE2431L. This is because the gain of the SE2431L can be viewed as a function of both the on-chip capacitance and the external impedance contributions. Internal on-chip routing and capacitance, bond wires (often several in parallel), the PCB transmission lines, the thermal reliefs on the decoupling capacitors' ground nodes, capacitance and parasitic of the decoupling capacitors, the inductance of the vias to the ground plane and the soldering of the chip will therefore contribute to the actual performance of the SE2431L.

A few comments can be made on how changing layout and PCB stack-up affects the amplifier:

- Misplacing the decoupling capacitor or using an arbitrary capacitor will change the inductance, and move the resonance frequency of the amplifier (the frequency with maximum gain).
- Bad soldering of the ground paddle can reduce the gain significantly.
- Too few or too long vias will reduce the gain significantly. This is why a checkered pattern of vias and solder paste and a 4-layer PCB with the ground plane close to the top layer has been chosen for the CC2530 - SE2431LEM reference design [\[10\]](#).
- Decoupling capacitor should only decouple specific pins and should be placed close to them
- Differential RF paths should be symmetrical
- There should not be any ground plane or routing under the antenna
- Copper islands and peninsulas with no ground vias should be removed
- Add ground vias close to pads of components with ground connections
- For stable ground and thermal conductivity a 5x3 matrix of vias is recommended under SE2431L

7 Controlling the SE2431L

There are four digital control pins (CSD,CPS,CTX and ANT_SEL) on the SE2431L. [Table 9](#) shows the control logic and [Figure 11](#) shows control connectivity with CC2530.

Table 9. Control Logic for Connecting the SE2431L to a CC2530 Device

CPS	CSD	CTX	ANT_SEL	Mode of Operation
0	0	0	X	All off (sleep mode)
0	1	0	X	RX Bypass mode
1	1	0	X	RX LNA mode
X	1	1	X	TX mode
X	1	X	0	ANT1 port enable
X	1	X	1	ANT2 port enable

The CC2530 – SE2431LEM reference design [10] from TI uses four GPIO pins on the CC2530 to control the SE2431L. The I/O pins used is shown in Figure 11.

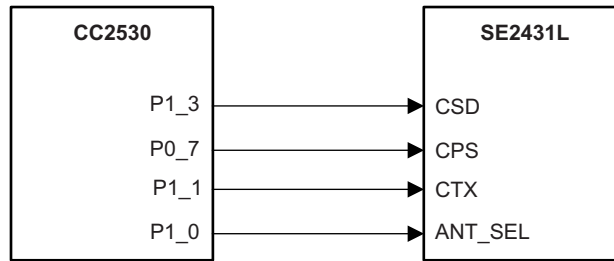

Figure 11. CC2530-SE2431L Interconnect

8 Configuring the Combo With SmartRF Studio and SmartRF05EB Board

Register settings, when using the CC2530-SE2431L combo, are automatically implemented in SmartRF Studio when checking the Range Extender box. It is highly recommended that SmartRF Studio 7 be used to optimize the register settings of the combo for any particular application and to pass the regulatory requirements. A screenshot of the SmartRF Studio user interface for CC2530-CC2591 is shown in Figure 12.

The control signals to CC2591 have 1-to-1 mapping for SE2431L as well that is:

- To configure CC2530-SE2431L, select the CC2591 in the Range Extender Box in the pull down menu.
- Checking the High Gain Mode box enables the RX LNA Mode for CC2530-SE2431L combo.
- Un-checking the High Gain Mode box enables the RX Bypass Mode on CC2530-SE2431L combo.
- The TX tab enables the TX Mode on the CC2530-SE2431L combo.

All measurements in this application report were made on the SMA connector, which is connected to pin 13 of SE2431L. To route RF signal on pin 13, the registers encircled in red must be set to values shown in Figure 12. This will set P1_0 of the CC2530 and route the RF signal to the SMA.

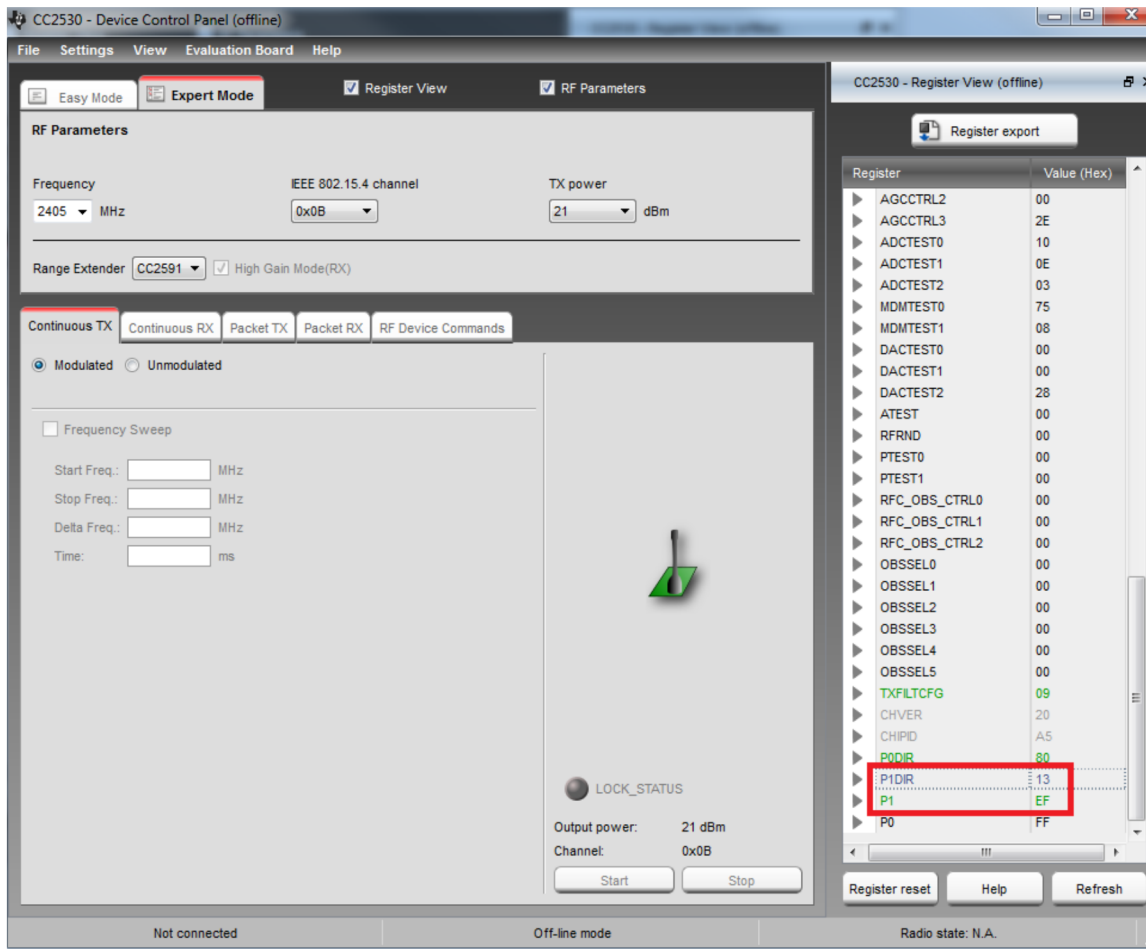

Figure 12. CC2530-SE2431L Interconnect Register Settings

9 References

1. CC2530F32, CC2530F64, CC2530F128, CC2530F256 A True System-on-Chip Solution for 2.4-GHz IEEE 802.15.4 and ZigBee Applications ([SWRS081](#))
2. CC253x System-on-Chip Solution for 2.4-GHz IEEE 802.15.4 and ZigBee® Applications ([SWRU191](#))
3. SE2431L: 2.4 GHz ZigBee®/802.15.4 Front-End Module (http://www.skyworksinc.com/uploads/documents/SE2431L_202410D.pdf)
4. TIMAC and Z-Stack Modifications for using CC2591 RF Front End with CC2530 ([SWRA290](#))
5. AN058 - Antenna Selection Guide ([SWRA161](#))
6. DN007 - 2.4 GHz Inverted F Antenna ([SWRU120](#))
7. IEEE std. 802.15.4 – 2006: Wireless Medium Access Control (MAC) and Physical Layer (PHY) specification for Low Rate Wireless Personal Area Networks (LR-WPANs) (<http://standards.ieee.org/getieee802/download/802.15.4-2006.pdf>)
8. AN032 SRD regulations for license-free transceiver operation in the 2.4 GHz band ([SWRA060](#))
9. DA 00-705 Filing and Measurement Guidelines for Frequency Hopping Spread Spectrum Systems (http://www.fcc.gov/Bureaus/Engineering_Technology/Public_Notices/2000/da000705.doc)
10. CC2530 With Skyworks' SE2431L Range Extender FEM Reference Design (<http://www.ti.com/tool/cc2530-se2431l>)

IMPORTANT NOTICE

Texas Instruments Incorporated and its subsidiaries (TI) reserve the right to make corrections, enhancements, improvements and other changes to its semiconductor products and services per JESD46, latest issue, and to discontinue any product or service per JESD48, latest issue. Buyers should obtain the latest relevant information before placing orders and should verify that such information is current and complete. All semiconductor products (also referred to herein as "components") are sold subject to TI's terms and conditions of sale supplied at the time of order acknowledgment.

TI warrants performance of its components to the specifications applicable at the time of sale, in accordance with the warranty in TI's terms and conditions of sale of semiconductor products. Testing and other quality control techniques are used to the extent TI deems necessary to support this warranty. Except where mandated by applicable law, testing of all parameters of each component is not necessarily performed.

TI assumes no liability for applications assistance or the design of Buyers' products. Buyers are responsible for their products and applications using TI components. To minimize the risks associated with Buyers' products and applications, Buyers should provide adequate design and operating safeguards.

TI does not warrant or represent that any license, either express or implied, is granted under any patent right, copyright, mask work right, or other intellectual property right relating to any combination, machine, or process in which TI components or services are used. Information published by TI regarding third-party products or services does not constitute a license to use such products or services or a warranty or endorsement thereof. Use of such information may require a license from a third party under the patents or other intellectual property of the third party, or a license from TI under the patents or other intellectual property of TI.

Reproduction of significant portions of TI information in TI data books or data sheets is permissible only if reproduction is without alteration and is accompanied by all associated warranties, conditions, limitations, and notices. TI is not responsible or liable for such altered documentation. Information of third parties may be subject to additional restrictions.

Resale of TI components or services with statements different from or beyond the parameters stated by TI for that component or service voids all express and any implied warranties for the associated TI component or service and is an unfair and deceptive business practice. TI is not responsible or liable for any such statements.

Buyer acknowledges and agrees that it is solely responsible for compliance with all legal, regulatory and safety-related requirements concerning its products, and any use of TI components in its applications, notwithstanding any applications-related information or support that may be provided by TI. Buyer represents and agrees that it has all the necessary expertise to create and implement safeguards which anticipate dangerous consequences of failures, monitor failures and their consequences, lessen the likelihood of failures that might cause harm and take appropriate remedial actions. Buyer will fully indemnify TI and its representatives against any damages arising out of the use of any TI components in safety-critical applications.

In some cases, TI components may be promoted specifically to facilitate safety-related applications. With such components, TI's goal is to help enable customers to design and create their own end-product solutions that meet applicable functional safety standards and requirements. Nonetheless, such components are subject to these terms.

No TI components are authorized for use in FDA Class III (or similar life-critical medical equipment) unless authorized officers of the parties have executed a special agreement specifically governing such use.

Only those TI components which TI has specifically designated as military grade or "enhanced plastic" are designed and intended for use in military/aerospace applications or environments. Buyer acknowledges and agrees that any military or aerospace use of TI components which have **not** been so designated is solely at the Buyer's risk, and that Buyer is solely responsible for compliance with all legal and regulatory requirements in connection with such use.

TI has specifically designated certain components as meeting ISO/TS16949 requirements, mainly for automotive use. In any case of use of non-designated products, TI will not be responsible for any failure to meet ISO/TS16949.

Products

Audio	www.ti.com/audio
Amplifiers	amplifier.ti.com
Data Converters	dataconverter.ti.com
DLP® Products	www.dlp.com
DSP	dsp.ti.com
Clocks and Timers	www.ti.com/clocks
Interface	interface.ti.com
Logic	logic.ti.com
Power Mgmt	power.ti.com
Microcontrollers	microcontroller.ti.com
RFID	www.ti-rfid.com
OMAP Applications Processors	www.ti.com/omap
Wireless Connectivity	www.ti.com/wirelessconnectivity

Applications

Automotive and Transportation	www.ti.com/automotive
Communications and Telecom	www.ti.com/communications
Computers and Peripherals	www.ti.com/computers
Consumer Electronics	www.ti.com/consumer-apps
Energy and Lighting	www.ti.com/energy
Industrial	www.ti.com/industrial
Medical	www.ti.com/medical
Security	www.ti.com/security
Space, Avionics and Defense	www.ti.com/space-avionics-defense
Video and Imaging	www.ti.com/video

TI E2E Community

e2e.ti.com