

TI Designs: TIDA-050018

待机功耗为 $6\mu\text{A}$ 且适用于多功能传感器的低功耗 AAA 电池参考设计



说明

该参考设计演示了用于门窗传感器的低功耗升压转换器解决方案。该设计包括一节碱性电池、一个超低静态电流升压转换器和超低功耗数字霍尔效应传感器。它还可以为用于传输传感器状态的超低功耗低于 1GHz 无线微控制器供电。

资源

TIDA-050018	设计文件夹
TPS61098	产品文件夹
DRV5032	产品文件夹
TIDA-01066	设计文件夹

特性

- 通过碱性电池供电
- 300nA 超低 IQ 升压转换器
- 适用于噪声敏感型负载的集成 LDO
- 磁场感应始终处于通电状态，可实现连续监控
- 双传感器架构可检测出干扰性磁体

应用

- 楼宇自动化
- 门窗传感器
- 家庭远程控制



咨询我们的 E2E™ 专家

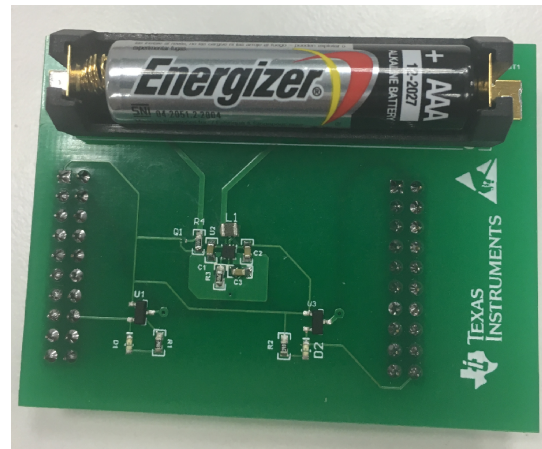
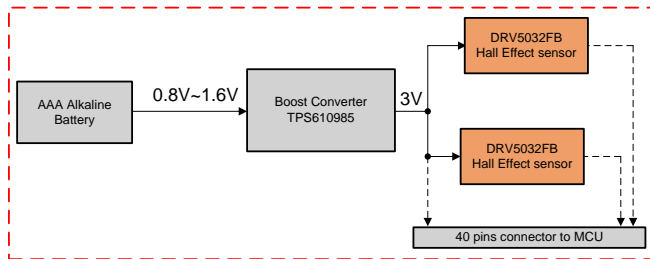

该 TI 参考设计末尾的重要声明表述了授权使用、知识产权问题和其他重要的免责声明和信息。

1 System Description

Many industrial and building automation systems use sensors to monitor whether the doors and windows are opened or closed. A central monitoring device generates alarms based on the information from multiple door and window sensors. These systems require wireless sensor nodes to reduce installation costs and to make the systems more flexible for future expansion. The wireless sensor node is powered by a battery, the voltage of which depends on the battery type and the remaining capacity. For example, the voltage of an alkaline battery varies from 1.5 V to 0.8 V in its operating lifetime. Magnets are commonly used in window and door sensor node to determine if a window or door is opened or closed. In a typical configuration the magnet is embedded in the window or door, and the sensor is attached to the window or door frame. The sensor and magnet are placed so that they are in close proximity when the door or window is closed and away from each other when the window or door is opened. Texas Instruments' ultra-low-power digital Hall effect sensors are designed for such applications. Besides magnets, shock sensors can be also used to detect the motion of the door or window. The power supply for the Hall effect sensors is at least 1.8 V, thus an ultra-low IQ boost converter is required if the system is supplied by an alkaline battery. The output of the boost converter also provides stable voltage to the ultra-low-power wireless microcontroller (MCU). The wireless MCU is required to transmit the sensor status to the central monitoring device.

This reference design includes an alkaline battery, an ultra-low IQ boost converter, and two ultra-low-power digital Hall effect sensors. The reference design can be connected with the CC1310 LaunchPad™ through two receptacles to demonstrate the wireless communication function in the security system.

1.1 Key System Specifications

表 1. Key System Specifications

PARAMETER	SPECIFICATIONS
Input power source	AAA alkaline battery, voltage from 1.6 V to 0.8 V
Output voltage of the boost	3 V
Output current capability of the boost	90 mA at 1.2-V battery voltage
Sensor sampling frequency	5 Hz
Sensor type	Hall effect
Average standby current consumption	6 μ A at 25°C room temperature

2 System Overview

2.1 Block Diagram

图 1. TIDA-050018 Block Diagram

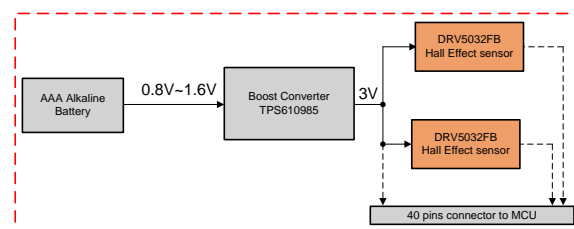

2.2 Highlighted Products

This TI Design features the following devices:

- TPS61098 ultra-low quiescent current synchronous boost with integrated LDO or load switch
- DRV5032 ultra-low power digital-switch Hall effect sensor

The 40-pin connector enables the board attaching to a wireless MCU CC1310 launch pad. More information about configuration of the wireless MCU can be found in the reference design [Low Power Door/Window Sensor with Sub-1GHz and 10-Year Battery Life Design Guide](#).

2.2.1 TPS610985

TPS610985 is an ultra-low quiescent-current synchronous boost. It integrates a LDO or low switch depend on the version. the device has two operation modes controlled by MODE pin: active mode and low-power mode. In active mode, both outputs are enabled with enhanced response performance. In low-power mode, the LDO or load switch is disabled to disconnect the peripheral components. The TPS61098x consumes only 300-nA quiescent current and can achieve up to 88% efficiency at 10- μ A load in low-power mode. The TPS61098x can provide up to 50-mA total output current at 0.7-V input to 3.3-V output conversion. The TPS610985 device is based on a hysteretic current controller topology, and it integrates synchronous rectifier to obtain maximum efficiency. The TPS61098x is available in 1.5-mm \times 1.5-mm WSON package to enable small circuit layout size.

2.2.2 DRV5032

The DRV5032 is an ultra-low-power digital switch Hall effect sensor, designed for the most compact and battery-sensitive systems. The device is offered in multiple magnetic sensitivities, sampling rates, output drivers, and packages to accommodate various applications.

When the applied magnetic flux density exceeds the B_{OP} threshold, a device output drives a low voltage. The output stays low until the flux density decreases to less than B_{RP} , and then the output either becomes high-impedance or drives a high voltage, depending on the device version. By incorporating an internal oscillator, the DRV5032 samples the magnetic field and updates the output at a rate of 20 Hz, or 5 Hz for the lowest current consumption. Both omnipolar and unipolar magnetic responses are available. The features of DRV5032 include:

- Industry-leading ultra-low power consumption
- 1.65-V to 5.5-V operating range
- Omnipolar or unipolar magnetic response
- 20-Hz and 5-Hz sample rate options
- SOT-23 or small SON package

In the DRV5032 product folder, there is a *magnetic field calculator* as shown in [图 2](#). For the NdFeB grade-38 6-mm cylinder magnet components, the distance toggling the signal in OUT is approximately 20 mm.

图 2. Magnetic Field Calculator

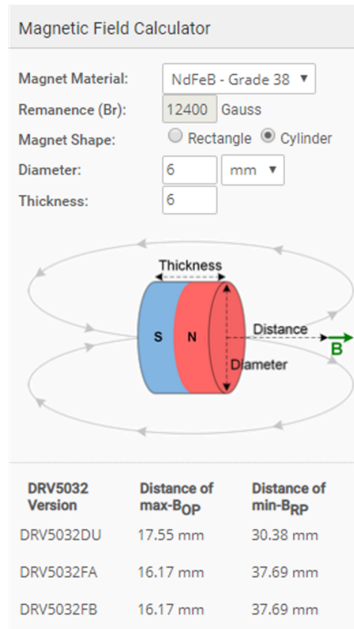

2.3 System Design Theory

The designed circuit can be divided into boost converter power solution and the Hall effect sensor circuit.

2.3.1 Power Supply Design

The circuit of the boost converter is shown in 图 3. The TPS610985 requires three components to generate 3 V from an alkaline battery input: input capacitor, inductor, and output capacitor. For this application, it is sufficient to have 10- μ F ceramic capacitor for the input and output. The inductor is 4.7 μ H with at least 400-mA current capability. For TPS610985, there is a switcher between the VMAIN and VSUB. When MODE pin is logic low, the switcher is off, so there is no voltage in the VSUB. When MODE pin is logic high, the switching is on, so the VSUB voltage follows the voltage of VMAIN. The VSUB can be used to power the loading, which consumes lots of energy but is not frequently powered up. Because the device consumes more quiescent current when MODE is high, the VSUB should be turned off for most of the time.

图 3. Boost Converter Schematic

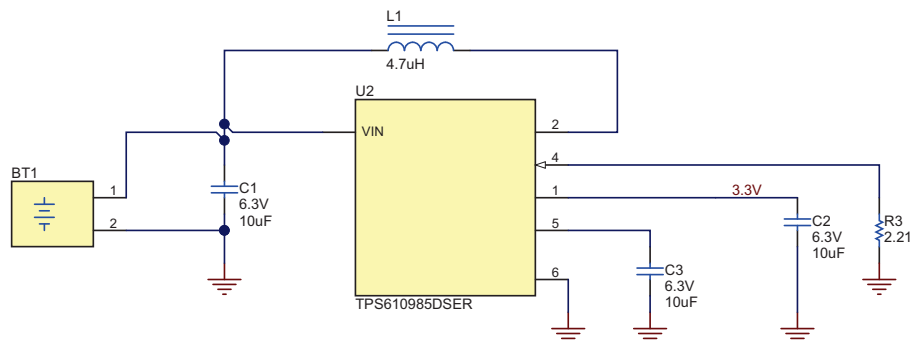

2.3.2 Hall Effect Sensor Design

The external circuit is shown in 图 4. The power supply is 3 V. The LED indicates the changing of the magnetic field. if the magnetic field is higher than typical 3 mT , the OUT pin output logic is low, and the LED D2 turns on. The OUT pin becomes logic high again if the magnetic field is lower than typical 1.5 mT.

图 4. Hall Effect Sensor Circuit

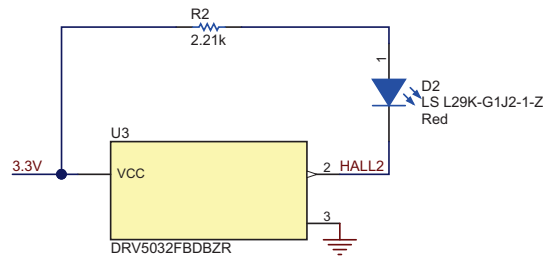

3 Test Results

The following shows the test results of this reference design. During the measurement, the power source can be electronic power supply or an alkaline battery.

3.1 Standby Current Consumption

表 2 shows the standby input current of the reference design at different input voltages. The input current is approximately 6 μA from typical 1.2-V battery voltage.

表 2. Standby Input Current

PARAMETER	BATTERY OUTPUT CURRENT AT DIFFERENT VOLTAGE							
Battery voltage (V)	0.8	0.9	1	1.1	1.2	1.3	1.4	1.5
Standby current (μA)	10	8.4	7.3	6.4	5.7	5.2	4.8	4.3

3.2 Boost Converter Operating Waveform

In standby condition, the TPS610981 operates at burst mode as the loading is very small. In the burst mode, the device switches several cycles to ramp up the V_{OUT} , and then most of the internal circuit shuts down to reduce power loss. After the output voltage decreases to a threshold, the device starts to switch again. The output ripple is approximately 20 mV shown in

图 5. Boost Converter Output Ripple at Standby Mode

图 6 和 图 7 显示 TPS610981 的负载瞬态性能。当输出电流为零时，器件工作在突发模式。突发模式的平均输出电压约为 3.1 V，比设置 3-V 输出高 100 mV，因为器件的内部电路需要额外的 100 mV 来进入或退出突发模式。当负载增加到 10 mA 或 50 mA 时，器件退出突发模式。输出电压调节到 3 V。

图 6. Boost Load Transient From 0 mA to 10 mA

图 7. Boost Load Transient From 0 mA to 50 mA

3.3 Magnet Response

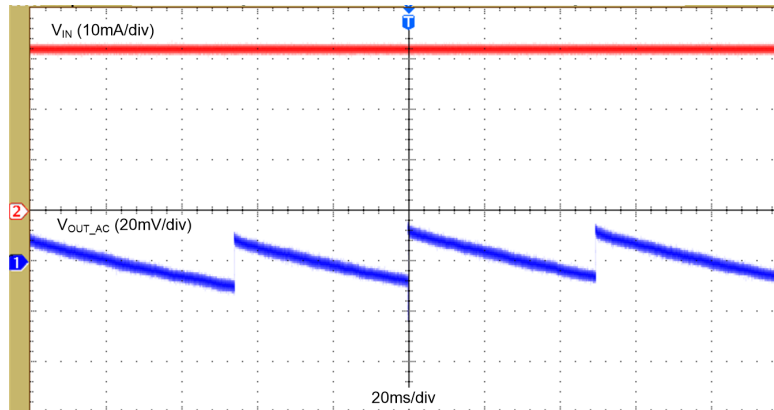
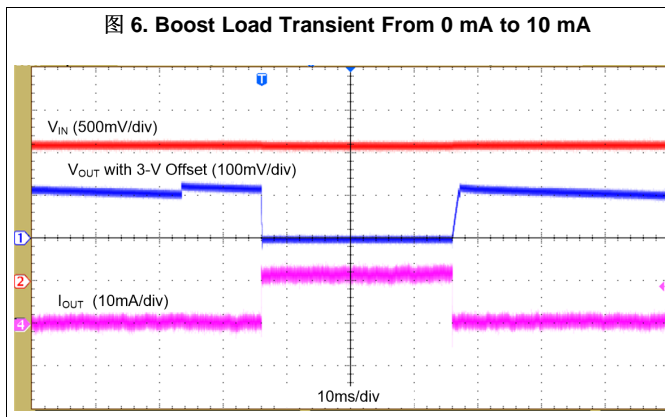
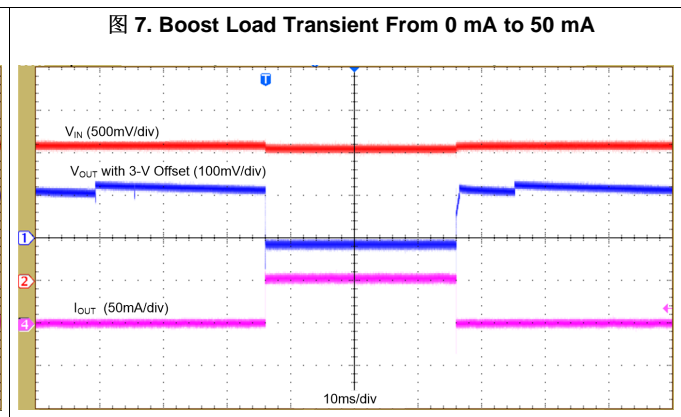
在图 8 中，一个圆柱形磁铁（6-mm 直径和 6-mm 高）放置在霍尔效应传感器 DRV5032 的顶部。如果传感器和磁铁之间的距离短于大约 16 mm，传感器输出逻辑低并点亮红色 LED。如果距离长于大约 22 mm，传感器输出逻辑高并熄灭 LED。在图 9 中，磁铁放置得更近，所以两个传感器的输出逻辑低以指示磁铁篡改。

图 8. Magnetic Field Test



图 9. Magnetic Field Test (Close Up)



3.4 Battery Life Estimation

The battery-life time depends on the energy consumption of the loading as well as the self-discharge of the battery. An alkaline battery loses approximately 3% of its capacity per year when stored at 20°C due to slow electrochemical reactions that continually occur. Warm temperatures increases the reaction. At 40°C, the battery loses 20% of its capacitance after five years of storage.

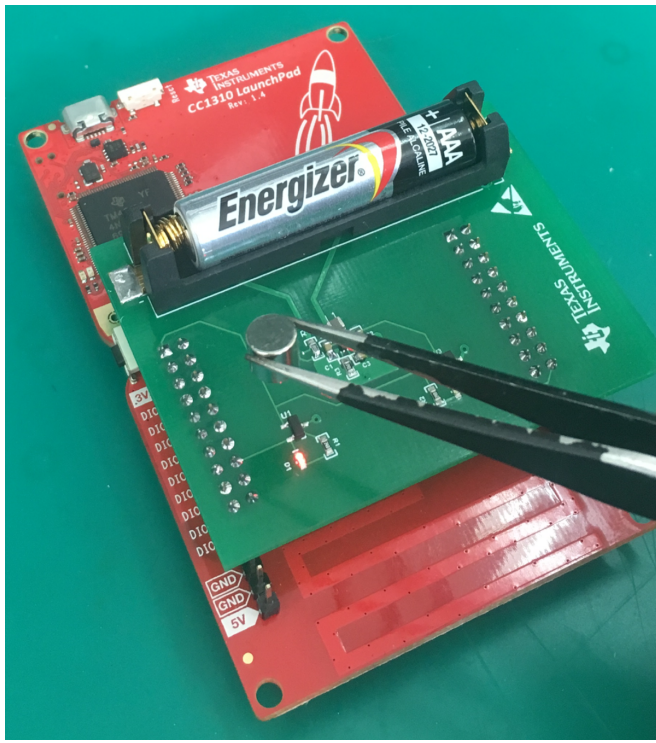
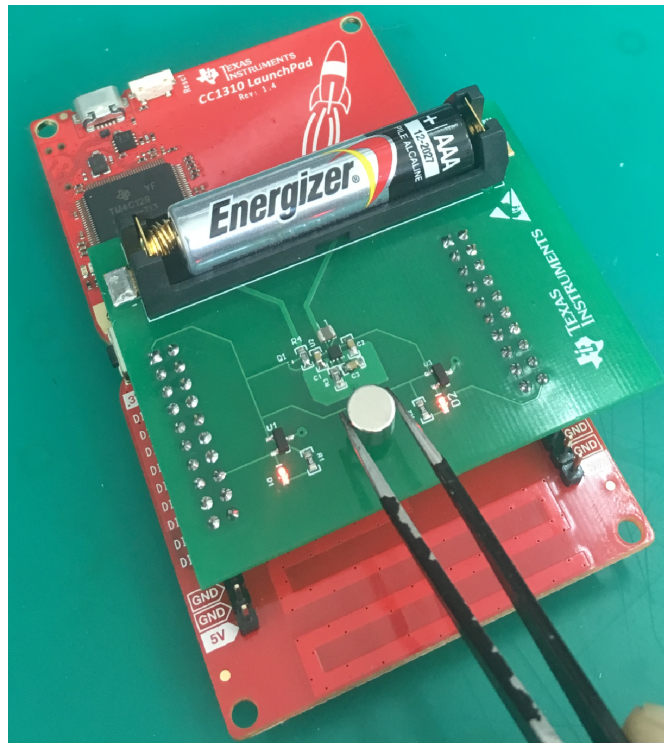
In this reference design, the alkaline battery is an AAA type. Its typical capacity relates to the discharge current. Using an Energizer alkaline battery as an example, the capacitor is approximately 1100 milliamp-hour at 25-mA discharging current and 900 milliamp-hour at 100-mA discharging current. In this application, the maximum loading current is less than 10 mA caused by the wireless packet transmit. The current out of the battery is less than 30 mA, so 1100 milliamp-hour (mAh) battery capacity can be used to estimate the battery life time.

Considering 5-years lifetime, the total capacity is used by the loading is approximately 880 mAh (0.8 × 1100 mA). Assuming 6-μA standby current, this current sums up to 260 mAh for 5 years, so there will be 520-mAh battery capacity left for the wireless device and other sensors. The average loading current from the output of the boost can then be calculated by 公式 1, which is approximately 4 μA.

$$I_{IN} = \frac{\text{Battery Capacity (mAh)}}{n \times 8760 \text{ hours}} \times \frac{V_{IN} \times \eta}{V_{OUT}}$$

where

- n is 5 years
- V_{IN} is the boost input voltage (average is 1.2 V)
- V_{OUT} is 3-V boost output voltage
- η is the efficiency of the boost, approximately 0.85

(1)

From the reference design [TIDUC69](#), the power consumption of the wireless communication is only 0.3 μA . Thus, there is approximately 3.7 μA for other loading, such as temperature sensor or humidity sensor.

4 Design Files

4.1 Schematics

To download the schematics, see the design files at [TIDA-050018](#).

4.2 Bill of Materials

To download the bill of materials (BOM), see the design files at [TIDA-050018](#).

4.3 PCB Layout Recommendations

4.3.1 Layout Prints

To download the layer plots, see the design files at [TIDA-050018](#).

4.4 Altium Project

To download the Altium Designer® project files, see the design files at [TIDA-050018](#).

4.5 Gerber Files

To download the Gerber files, see the design files at [TIDA-050018](#).

4.6 Assembly Drawings

To download the assembly drawings, see the design files at [TIDA-050018](#).

5 Related Documentation

1. [Low Power Door/Window Sensor with Sub-1GHz and 10-Year Battery Life Design Guide](#)
2. [TPS61098x Ultra-Low Quiescent Current Synchronous Boost with Integrated LDO/Load Switch](#)

5.1 商标

E2E, LaunchPad are trademarks of Texas Instruments.
Altium Designer is a registered trademark of Altium LLC or its affiliated companies.
All other trademarks are the property of their respective owners.

5.2 Third-Party Products Disclaimer

TI'S PUBLICATION OF INFORMATION REGARDING THIRD-PARTY PRODUCTS OR SERVICES DOES NOT CONSTITUTE AN ENDORSEMENT REGARDING THE SUITABILITY OF SUCH PRODUCTS OR SERVICES OR A WARRANTY, REPRESENTATION OR ENDORSEMENT OF SUCH PRODUCTS OR SERVICES, EITHER ALONE OR IN COMBINATION WITH ANY TI PRODUCT OR SERVICE.

重要声明和免责声明

TI 均以“原样”提供技术性 & 可靠性数据（包括数据表）、设计资源（包括参考设计）、应用或其他设计建议、网络工具、安全信息和其他资源，不保证其中不含任何瑕疵，且不做任何明示或暗示的担保，包括但不限于对适销性、适合某特定用途或不侵犯任何第三方知识产权的暗示担保。

所述资源可供专业开发人员应用 TI 产品进行设计使用。您将对以下行为独自承担全部责任：(1) 针对您的应用选择合适的 TI 产品；(2) 设计、验证并测试您的应用；(3) 确保您的应用满足相应标准以及任何其他安全、安保或其他要求。所述资源如有变更，恕不另行通知。TI 对您使用所述资源的授权仅限于开发资源所涉及 TI 产品的相关应用。除此之外不得复制或展示所述资源，也不提供其它 TI 或任何第三方的知识产权授权许可。如因使用所述资源而产生任何索赔、赔偿、成本、损失及债务等，TI 对此概不负责，并且您须赔偿由此对 TI 及其代表造成的损害。

TI 所提供产品均受 TI 的销售条款 (<http://www.ti.com.cn/zh-cn/legal/termsofsale.html>) 以及 [ti.com.cn](http://www.ti.com.cn) 上或随附 TI 产品提供的其他可适用条款的约束。TI 提供所述资源并不扩展或以其他方式更改 TI 针对 TI 产品所发布的可适用的担保范围或担保免责声明。

邮寄地址：上海市浦东新区世纪大道 1568 号中建大厦 32 楼，邮政编码：200122
Copyright © 2018 德州仪器半导体技术（上海）有限公司

重要声明和免责声明

TI 均以“原样”提供技术性 & 可靠性数据（包括数据表）、设计资源（包括参考设计）、应用或其他设计建议、网络工具、安全信息和其他资源，不保证其中不含任何瑕疵，且不做任何明示或暗示的担保，包括但不限于对适销性、适合某特定用途或不侵犯任何第三方知识产权的暗示担保。

所述资源可供专业开发人员应用 TI 产品进行设计使用。您将对以下行为独自承担全部责任：(1) 针对您的应用选择合适的 TI 产品；(2) 设计、验证并测试您的应用；(3) 确保您的应用满足相应标准以及任何其他安全、安保或其他要求。所述资源如有变更，恕不另行通知。TI 对您使用所述资源的授权仅限于开发资源所涉及 TI 产品的相关应用。除此之外不得复制或展示所述资源，也不提供其它 TI 或任何第三方的知识产权授权许可。如因使用所述资源而产生任何索赔、赔偿、成本、损失及债务等，TI 对此概不负责，并且您须赔偿由此对 TI 及其代表造成的损害。

TI 所提供产品均受 TI 的销售条款 (<http://www.ti.com.cn/zh-cn/legal/termsofsale.html>) 以及 [ti.com.cn](http://www.ti.com.cn) 上或随附 TI 产品提供的其他可适用条款的约束。TI 提供所述资源并不扩展或以其他方式更改 TI 针对 TI 产品所发布的可适用的担保范围或担保免责声明。

邮寄地址：上海市浦东新区世纪大道 1568 号中建大厦 32 楼，邮政编码：200122
Copyright © 2018 德州仪器半导体技术（上海）有限公司