

Introduction to Time-of-Flight Long Range Proximity and Distance Sensor System Design

This user's guide provides information about *Time-of-Flight* (ToF) long range proximity and distance sensor system design. This document describes the detailed functionality of ToF proximity systems, explains the trade-offs involved in a typical ToF system and provides a step-by-step design flow.

Contents

1	Introduction	2
2	Time-of-Flight Long Range Proximity and Distance Sensing Basics	2
3	Technology Selection	5
4	System Definition	9
5	Photodiode Selection	18
6	Illuminator Selection	21
7	Optics Design	25
8	PCB Design	34

List of Figures

1	Generic ToF Proximity Sensor System	3
2	Generic Time-of-Flight Timing Diagram	3
3	Vector Diagram Representation for ToF Signal	4
4	OPT3101-Based System	4
5	ATM Kiosk person detection system	9
6	Multi-Zone Arrangement Examples With OPT3101	10
7	Emitter and Receiver Fields-of-View.....	11
8	Type of Targets Based on Reflectance	14
9	Performance Target Definitions	16
10	Spectral Response of Different Emitters and Photodiodes in Comparison With Solar Spectrum	19
11	Reverse Biased Junction Capacitance Curve of Photodiode	20
12	Angular Responses of Photodiodes With Varying FoVs	21
13	Angular Emissions of LEDs With Various FoVs.....	23
14	Duty Cycle Thermal Limit Curve for LED	24
15	Ray diagram of transmit and receive light	25
16	Cover glass design for flat cover glass.....	27
17	Cover glass design for angled glass.....	27
18	Cover glass design for angled glass.....	27
19	Dual cavity common glass 3D example	28
20	Receiver Optics with and without Lens.....	29
21	photodiode positioning from lens.....	30
22	Thin lens ray optics diagram.....	31
23	Field of View with pin hole model	31
24	Field of view vs optical gain.....	32
25	Field of view overlap	33
26	Vector diagram with residue crosstalk.....	34

27	PCB Layout with magnetic field lines	36
28	PCB sections recommended	38
29	Good layout example 1	40
30	Good layout example 2	41
31	Good layout example 2	42

List of Tables

1	Technology Selection	5
---	----------------------------	---

Trademarks

All trademarks are the property of their respective owners.

1 Introduction

Time-of-flight (ToF) techniques have been used for ranging purposes for over more than a century. Now with technology advancements, the speed and size of electronics can build small and affordable ToF-based proximity sensor systems. The purpose of this document is to educate the reader about ToF proximity system design. There are several parameters that govern the performance of the system. This document describes the detailed functionality of ToF proximity systems, explains the trade-offs involved in a typical ToF proximity system and provides a step-by-step ToF system design flow.

1.1 Intended Audience

Use this document to:

- Design a new ToF long range proximity and distance sensor system using OPT3101
- Incorporate ToF long range proximity and distance sensor system in a solution
- Validate if ToF long range proximity and distance sensor is a suitable technology for an application
- Learn about ToF long range proximity and distance sensor systems trade-offs

1.2 Prerequisite Documentation

- [OPT3101 Long Range Proximity/Depth Sensor AFE](#)
- Time-of-Flight basics

2 Time-of-Flight Long Range Proximity and Distance Sensing Basics

Light emitter and a receiver form the sensing elements of an Optical time-of-flight (ToF) long range proximity and distance sensing system. The emitter sends modulated light pulses. The emitted light bounces off the objects in the scene and a part of the reflected light comes back to the receiver. The round trip time of the light pulses is measured by the analog front end. The measured time is an indicator of the distance to the object. Emitted light is pulsed continuously with a periodicity determined by the modulation frequency. Since emitted light is periodic, the phase difference between the emitted and the received light is an indicator of the round trip time. The phase determination is aggregated over several cycles of the periodic light modulation.

2.1 Generic ToF Long Range Proximity and Distance Sensor System

The simplest form of ToF long range proximity and distance sensing system consists of a modulated light source as emitter (light source like LED or laser) and a single, high-speed photodiode as a receiver.

Figure 1 shows such a generic ToF long range proximity and distance sensing system which measures phase (a representation of distance) to the target. The target here is defined as the object on which the emitted light falls. The area of detection on the target is dependent on the properties of the light source. The number of points on the target for which independent measurements are desired help decide on the type of ToF system to be designed. There are 3D ToF camera products from TI which have the capability of measuring several different points on a scene though a lens. The [Introduction to the Time-of-Flight \(ToF\) System Design](#) user's guide explains the 3D ToF system design process. The scope of this document covers the ToF long range proximity and distance sensor Analog Front End (AFE) OPT3101, which is able to measure up to 3 independent targets.

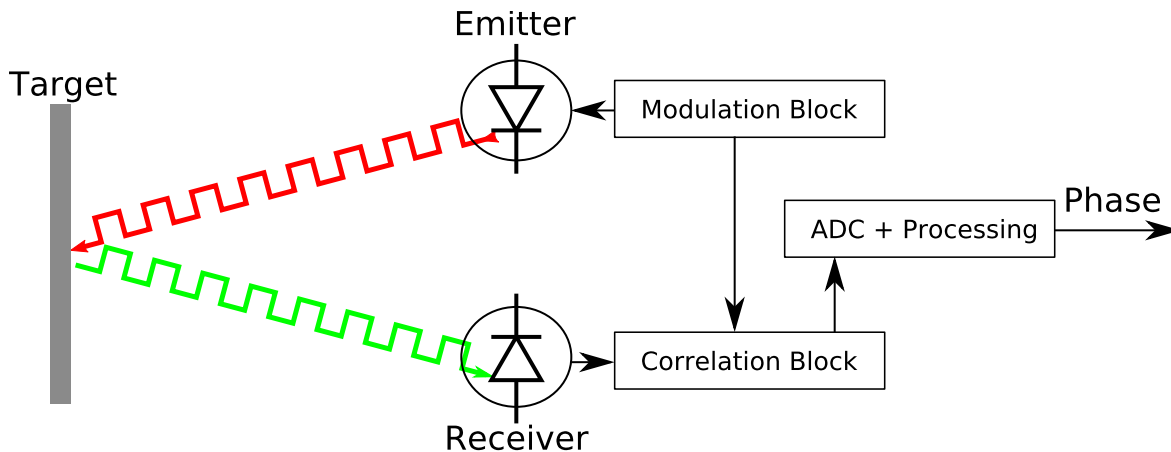

Figure 1. Generic ToF Proximity Sensor System

Figure 2 shows the emitter signal and receiver signal pulse train timing diagram. Since the modulation frequency here is assumed to be 10 MHz, the cycle time for each pulse is 100 ns. As previously mentioned, systems integrate over several modulation cycles before computing the target phase. The target phase is clearly a representation of the distance to the target. Systems are designed to extract the target phase information independent of the level or amplitude of the returning signal.

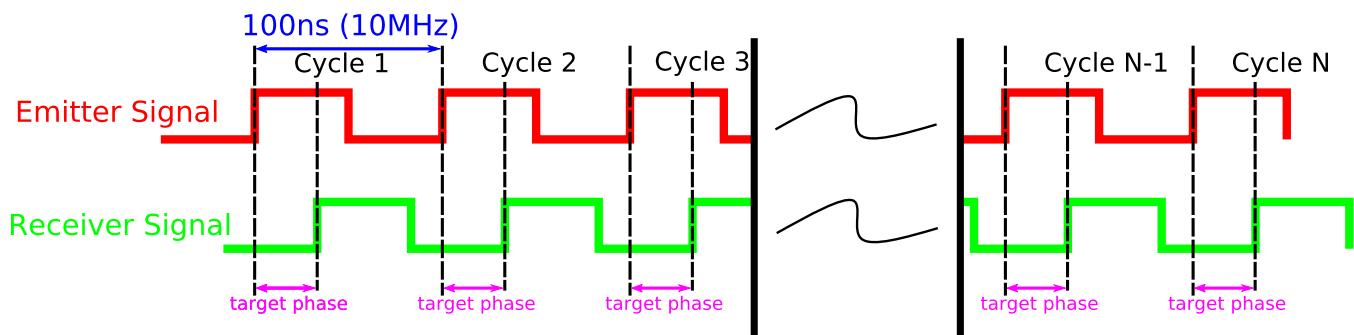

Figure 2. Generic Time-of-Flight Timing Diagram

Typically, the incoming signal is separated into *In phase* and *Quadrature* components to extract the target phase information independent of signal amplitude. Figure 3 shows vector representation of the signal. One can imagine that the effective target phase aggregated over several cycle of 100 ns (for 10 MHz). In the vector diagram (see Figure 3), the angular axis represents time or phase and the radial axis represents the signal amplitude. The same can also be looked as having *In Phase* and *Quadrature Phase* axis as represented in Figure 3.

When plotted, the signal looks like a vector, casting an angle determined by target phase and the length determined by signal amplitude. IComponent and QComponent are the projections of the signal vector onto the *In Phase* and *Quadrature Phase* Axes.

The ToF system signal chain is designed to extract the target phase without dependency on the signal amplitude, thus making the distance measurement independent of the object reflectivity or color. There is a maximum signal level that can be handled by the system called the full scale amplitude as shown in Figure 3 (normally referenced to as 0 decibels full scale or 0 dBFS), thus all signal amplitudes lower than the full scale are represented in negative dBFS values. For example -20 dBFS signal relates to signal amplitude 10 times smaller than the full scale amplitude.

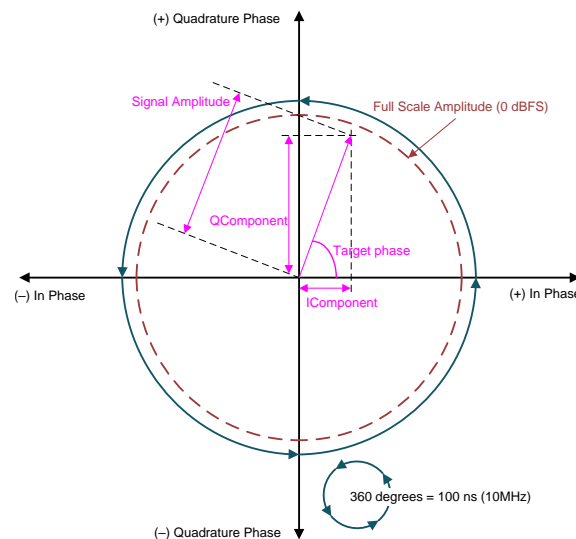

Figure 3. Vector Diagram Representation for ToF Signal

2.2 OPT3101-Based ToF Long Range Proximity and Distance Sensor

Figure 4 shows a simple ToF long range proximity and distance sensing system based on the OPT3101. The OPT3101 is an AFE only, and along with light emitters and photodiode forms a fully-functional system. The AFE measures the phase representing the distance to the target.

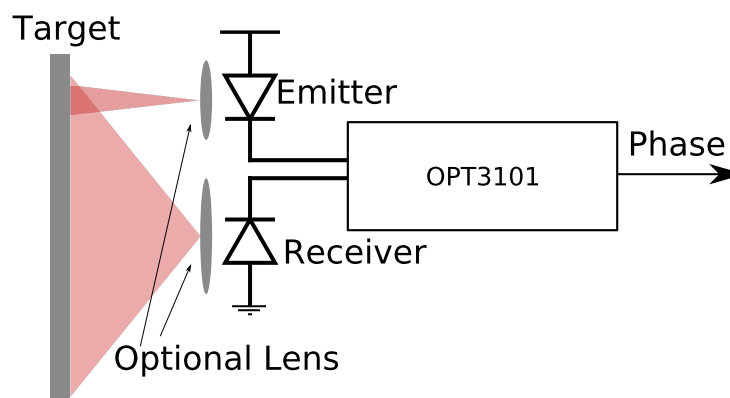

Figure 4. OPT3101-Based System

A more detailed system block diagram is found in [OPT3101 Long Range Proximity/Depth Sensor AFE](#).

3 Technology Selection

This section helps readers determine if an OPT3101-based system is right for their application. There are several different types of applications needing proximity sensing, each having different requirements in terms of detection range, detection rate, power, and field-of-view (FoV) to name a few. This technology is compared with respect to other sensing technologies in this section.

Table 1. Technology Selection

TECHNOLOGY	APPLICATIONS	PROS	CONS
Optical		<ul style="list-style-type: none"> • Lower cost • High sample rate possible • Small form factor • Insensitive to wind, air temperature and humidity • Simpler-to-design system (desired FoV) 	<ul style="list-style-type: none"> • Fails to work in rain and fog • Some methods are sensitive to high ambient light
SPAD-integrated, direct ToF module	Short range proximity. Typically < 1 to 2 meters. Mobile proximity	<ul style="list-style-type: none"> • Extremely small size • Accurate at short range • Low cost 	<ul style="list-style-type: none"> • Severe performance issues at high ambient and outdoor • Suffers performance issues with larger FoV (more than 25° or 30°) • Limited module options available in market • Low data rate (< 100 samples per second)
APD discrete-based direct ToF	Long-range precision distance meters	<ul style="list-style-type: none"> • High precision even at long range 	<ul style="list-style-type: none"> • Very low data rate (approximately 1 sample per second) • Large size (50 mm x 25 mm x 35 mm) • Requires precision manufacturing assembly and calibration • High cost due to discrete components • High voltage biasing required for APD
OPT3101 continuous time (indirect) ToF-based system	Short (< 2) and Medium range (approximately 15 m) ranging and proximity detection	<ul style="list-style-type: none"> • Low cost • Very high sample rate (4000 samples per second) • Excellent high ambient performance • Multi-target and multi-channel capability • Can be made to fit in a small form factor • Variety of FoV, accuracy and so forth, (system condition) optimizations possible 	<ul style="list-style-type: none"> • Not suitable for applications demanding very small size, such as mobile • Difficult to achieve sub-mm precision • Excellent noise performance but absolute error higher than competing technologies due to 2nd order effects
Amplitude-based proximity sensing	Very short range proximity detection (< 100 mm)	<ul style="list-style-type: none"> • Very low Cost 	<ul style="list-style-type: none"> • Performance depends on target reflectivity • Suffers performance issues in higher ambient conditions • Not suitable for longer range applications
Ultrasonic		<ul style="list-style-type: none"> • Low cost • Insensitive to ambient lighting conditions • Low power • Works in rain and fog 	<ul style="list-style-type: none"> • Performance depends on surface and angle of attack. Hard surfaces cause specular reflections resulting in poor return signal. Soft targets yield poor return signal • Slow data rate (limited by speed of sound) • Sensitive to humidity, wind and air pressure. • The size not as small as optical systems • Hard to achieve narrow FoV

Table 1. Technology Selection (continued)

TECHNOLOGY	APPLICATIONS	PROS	CONS
Passive infrared		<ul style="list-style-type: none"> • Extremely low power • Very low cost 	<ul style="list-style-type: none"> • Detects only change or movement • Detects only on heat signature changes (human or animals) • Does not report position of target • Fails to work on inorganic targets

Answers to the following key questions must be obtained before deciding if the OPT3101 technology suits the application needs:

What application function is the OPT3101 system fulfilling?

- For example: Person detection in ATM kiosk

In the current system is there a technology that fulfills the function already?

What is the technology that currently fulfills the function?

- If the current system fulfills the function already:
 - If existing function uses optical technology:
 - Is there a limitation to existing solution? Compared to existing solution if application demands:
 - Better ambient light performance: OPT3101-based system is a good fit.
 - Higher Data rate: OPT3101-based system is a good fit.
 - Multiple target capability: OPT3101-based system is a good fit.
 - Variety in FoV, optics, or wavelength: OPT3101-based system is a good fit.
 - Is the existing technology based on SPAD integrated direct time-of-flight module?
 - OPT3101 can offer higher frame rate, higher ambient performance system in a larger size or form factor.
 - OPT3101-based system when compared:
 - Can be designed to have higher range (way more than 2 meters)
 - Operates at very high data rates
 - Performs at very high ambient light conditions
 - Has the flexibility to design any optics and wavelengths
 - OPT3101-based system when compared:
 - Cannot be as small as existing technology
 - Is not yet available in module form, hence needs integration of emitters, photodiodes, and optics components on the PCB
 - Cannot meet short-range accuracy as good as the existing technology
 - Is the existing technology based on discrete APD discrete-based direct ToF?
 - OPT3101-based system can offer a lower cost, low-precision replacement
 - OPT3101-based system when compared:
 - Has significantly lower cost
 - Is a smaller size
 - Has a much higher data rate
 - OPT3101-based system when compared:
 - Cannot meet long range with accuracy
 - Is the existing technology amplitude-based proximity sensing?
 - OPT3101-based system can offer much more reliable and better performing system where results are independent of target type and ambient conditions
 - OPT3101-based system when compared:
 - Can meet longer range
 - Can measure independent of target reflectivity
 - Has a higher frame rate
 - Has higher accuracy and ambient performance
 - OPT3101-based system when compared, cannot or is not:
 - Lower cost
 - is more complex to design system

- If the existing technology is not optical technology:
 - Does optical technology work for the application?
 - Optical technology is not expected to work or has limitations in the following:
 - During rain or fog
 - When severe dust or floating particles are present
 - A medium that is not optically clear
 - When dust or debris settles on optics or sensors
 - Is the existing system based on ultrasonic?
 - OPT3101-based systems offer competitive cost as compared to existing solutions with a higher data rate and invariability to target material and environmental conditions
 - OPT3101-based system when compared, can or has:
 - a higher data rate
 - a narrower target selection
 - multi-target detection
 - more reliable detection, independent of the target material
 - insensitivity to wind, humidity, and air pressure
 - Is smaller size
 - OPT3101-based system when compared:
 - Is not accurate at shorter distances
 - Is the existing system based on passive infrared?
 - OPT3101-based system offers behavior detection and higher accuracy, but at higher power and higher cost
 - OPT3101-based system when compared:
 - Works on any target (organic and in-organic)
 - Not only detects change but absolute position of target
 - Has multiple independent target zone detection
 - OPT3101-based system when compared, cannot:
 - meet PIR cost
 - meet PIR power budget
 - meet PIR range for given power

4 System Definition

Since there are different system vectors that influence the design, it is helpful to know about all of the vectors options that are available, including the acceptable tolerances on the same system vector. Once a OPT3101-based system is chosen and considered a good fit for the application, the following approach is recommended before one selects the optical components.

An example of a system definition is shown in Figure 5, and the vectors are highlighted.

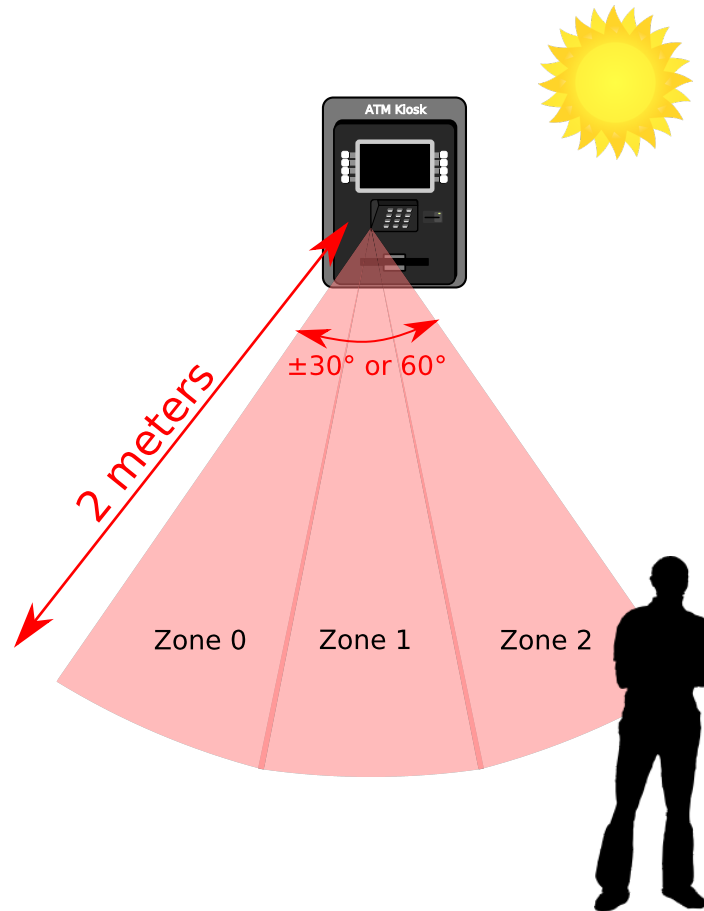

Figure 5. ATM Kiosk person detection system

Person detection in an ATM kiosk with:

3 zones of detection (with a single OPT3101), a **range** of up to 2 meters, an **accuracy** of $\pm 5\%$ (white target), a **field-of-view** of 20° (full angle) each **arranged linearly** to achieve 60° in total, running at **10 samples per second** with a **power drain** of 100 mW, **no lasers** accepted, **exempt group** lamp classification LED, expected to work at 130-kLux **ambient sunlight**, **no visible detection** wavelength.

This example is a comprehensive list of conditions and vector definitions which may not be readily available for all applications. In some applications, many of these vectors may be flexible and secondary; however, some key vectors are required to start the design process which involves selection and availability of discrete components. Once some of the critical decisions have been made, the remaining vectors fall in place and are analyzed to see if they are acceptable. The following sections list the vectors and conditions that are most important.

4.1 Number of Zones and Targets

This is one of the most important vectors to be known from the beginning. This influences many following system vectors. Key concerns while selecting the same follow:

- System cost:
 - Having more than 1 zone means more than 1 emitter component is required, adding to the system cost.
- System optics and design:
 - Some emitter components have integrated optics. Integrated optics generally emit light perpendicular to the mounted PCB plane.
 - If different emitters must direct light at different zones to segment the FoV, the system needs refractive optics (prisms or lens) or light-beaming reflectors.
- Size:
 - Physical size of the entire system with multiple emitters are typically larger than single-emitter systems. This is mainly due to the physical separation of the OPT3101 emitter control pins and the additional space required to maintain and follow the layout guidelines.
- Data rate and noise:
 - The data rate of systems using multiple emitters is lower than with single-emitter systems. For example, with 3 emitters to get an effective data rate of 10 fps (3 target measurements every 100 ms), the OPT3101 device needs to run at 30 fps. The AFE noise is worse by $\sqrt{3}$ due to the increased data rate.

Figure 6 shows some examples of how multiple zone detection can be realized. Since there are many more ways of arrangement, only the most common arrangements are shown. Systems requiring to detect target behavior in a three dimension could be implemented with the configuration shown in the left, the one requiring detection in a plane could be implemented with the configuration shown on the right.

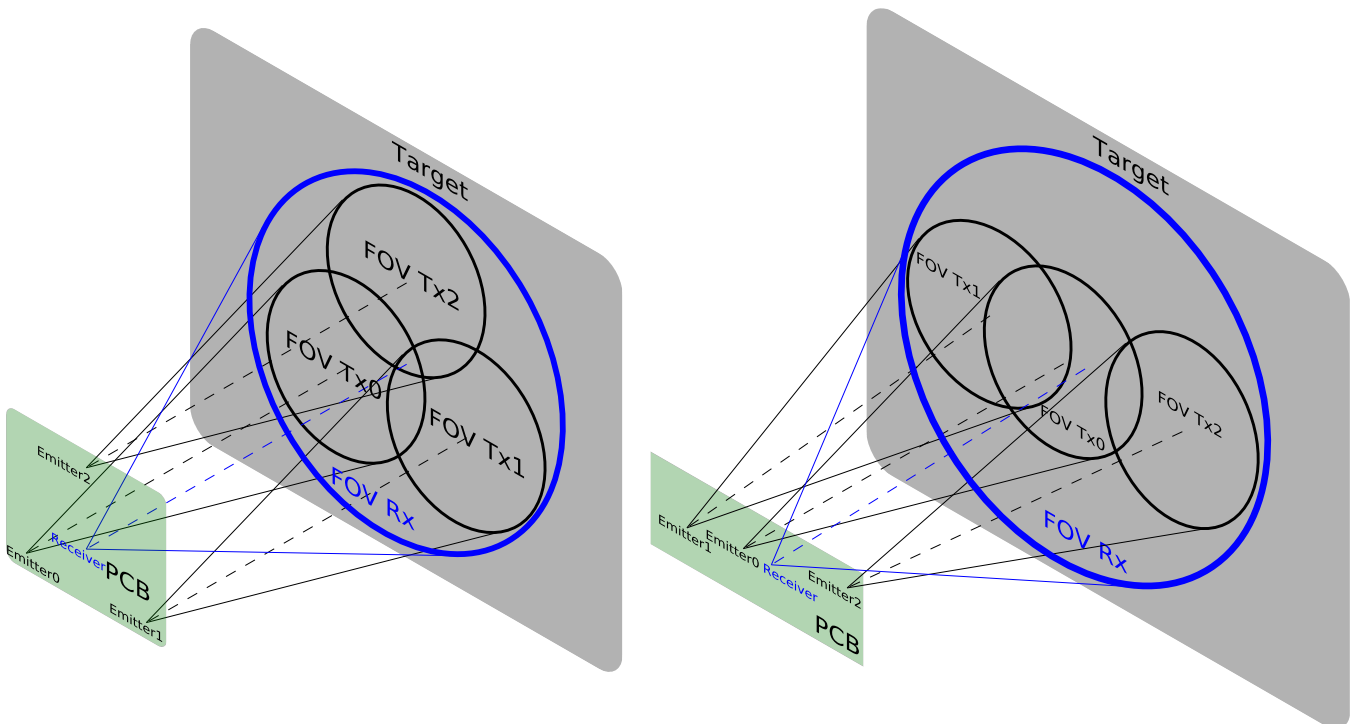

Figure 6. Multi-Zone Arrangement Examples With OPT3101

4.2 Field-of-View (FoV)

This primary vector must be understood because it determines the performance of the system. The performance of the system is a strong function of the FoV since many parameters are dependent on it. Generally, the narrower the FoV, the longer the range of the system. This section presents some of the trade-offs which helps decide the FoV.

There are 2 fields-of-view to be considered, the FoV of the emitter and the FoV of the receiver.

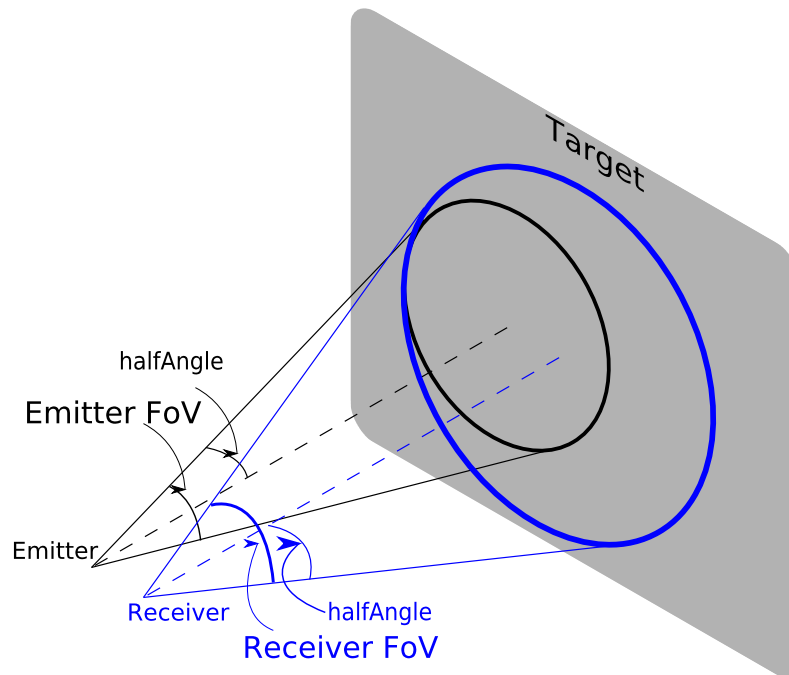

Figure 7. Emitter and Receiver Fields-of-View

4.2.1 Emitter FoV

Measured in degrees (\pm half angle or full angle), determination of this is crucial as it defines the target size at a given distance. This is expressed in half-angle or full-angle subtended by the cone of light emission.

To list as a simple statement, minimizing the FoV as small as possible (to a bare minimum, based on application requirement) helps improve the performance and range of the system.

4.2.1.1 Determination of Emitter FoV

Selection of FoV is application specific. Ranging applications demand extremely low emitter FoV whereas object or presence detection demands a large emitter FoV. Although some applications demand very large FoV, designing a system with a single large-emitter FoV becomes practically unusable.

For single-emitter systems, OPT3101 AFE measures distance of the target illuminated by the emitter. With a large emitter FoV the entire scene turns into a target, making the object of interest less prominent. For example: Imaging a presence-detection system in an ATM kiosk where the sensor is placed 1 meter from the ground. Assume the emitter FoV is $\pm 45^\circ$. Even with no human presence at the kiosk, the cone of the emitter would engulf the floor starting from 1 meter turning it to a target. The same is applicable to anything in the FoV, including other inanimate objects like chairs, tables, side walls and so forth. The system measures a weighted average distance of all objects in the FoV. A person walking towards the FoV from 2+ meters occupies an insignificant portion of the FoV causing a very small change to the distance (could be undetectable since objects closer, occupying larger portion of the FoV are weighted more), unless the person walks very close to the sensor. This severely limits the range of systems with large-emitter FoVs. The recommendation in such scenarios is to consider multiple emitters each with lower FoV directing light to different portions of the overall detection FoV, which gives more data points per measurement for meaningful behavior detection.

4.2.1.2 Impact of Eye and Skin Safety and Certification

Generally, for a given emitter power level the smaller the emitter FoV, the harder it gets to meet the eye and skin safety regulations. The more the concentration of light into a smaller cone (lower FoV), the more the power per unit area.

4.2.1.3 Achieving the Desired Emitter FoV

The required emitter FoV can be achieved using the following:

- There are fundamental limitations on how narrow or how wide the FoV reaches based on the optics design.
 - For example: Unless a stimulated emitter (covered in [Section 6.1.2](#)) is used, achieving a FoV lower than $\pm 5^\circ$ becomes extremely difficult.
- Achieving $\pm 90^\circ$ is nearly impossible due to the shadow caused by components on the PCB or the facade of the system.
- Some LED emitters come with integrated optics, the FoV of which is specified in the data sheet of the emitter.
- LED emitter fields-of-view are part of the data sheet (as explained in [Section 6.2.3](#)), typically available all the way from $\pm 5^\circ$ to $\pm 60^\circ$. Normally the choices are limited.
- Optics and lenses on top of LEDs could alter the FoV of the emitter, as desired.
- In case of specialized need, an optical assembly such a collimating lens can be used to achieve a particular emitter FoV. Refer to [Section 7.4](#) for more details.

4.2.2 FoV of Photodiode and Photo Receiver

Measured in degrees or steradians (\pm half angle or full angle), determination of this depends on the determination of the emitter FoV which in turn depends on the application demands. This can be expressed in half-angle or full-angle, subtended by the cone of light collection.

4.2.2.1 Determination of Photodiode FoV

Determination of this vector seems trivial; however, has a more profound impact on the system performance. Here are some of the things to keep in mind while determining this parameter

- Photodiode FoV needs to be equal to or larger than the emitter FoV for the following reasons:
 - PCB-to-PCB mounting tolerances of the components including optics
 - Spacing between emitter and photodiode placement on the PCB
- Performance is a strong function of FoV as explained in the following sections:
 - FoV has a great impact on both ambient light collection and signal light collection
 - First-order approximation for the respective gains are found using below formula. This shows that reducing the FoV increases both signal gain and reduces ambient gain improving performance by a great deal.

$$\text{signalGain} \propto \frac{1}{\left(\tan\left(\frac{fov}{2}\right)\right)^2}$$

$$\text{ambientGain} \propto \left(\tan\left(\frac{fov}{2}\right)\right)^2$$

(1)

4.2.2.2 Achieving the Desired Photodiode FoV

Photodiodes fall into one of 2 categories – with integrated optics and without integrated optics:

- In the case of photodiodes without integrated optics:
 - These typically have a cosine angular response curve with a FoV of $\pm 60^\circ$

- Optical gain can be considered to be 1, hence performing worst in terms of current generated per unit area of receiver for a given light power
- Only desirable when the FoV of the application demand is higher than approximately $\pm 45^\circ$
- Add optics or lens to increase the optical gain which translates to performance improvement.
 - Selection and optics design is explained in [Section 7.5.1](#)
- In the case of photodiodes with integrated optics
 - These have angular response curves as specified in their data sheet
 - For a given package type, the narrower FoV photodiodes tend to have higher optical gain, hence improving performance
 - The same approximate [Equation 1](#) holds for the photodiodes with integrated optics as well

4.3 Wavelength (λ)

The OPT3101 device being just an AFE, supports a wide variety of wavelengths subjected only to the availability of photodiode and emitter components. The following aspects help determine the wavelength of operation for the system

4.3.1 Visibility to Naked Eye

4.3.1.1 Visible Spectrum

Although it sounds trivial, the visible spectrum must be an important aspect to consider. In some systems like industrial ranging, safety requires the spot where the target distance is reported to be visually distinguished. This helps in lining up the system as desired. In such cases a visible light wavelength of 390 nm to 700 nm is desirable. Response of the human eye peaks around 500 nm to 550 nm, making green seem like natural choice for these applications, but the response of the photodiode components typically peak around 800 nm leaving behind a poor response for green. To strike a balance, red (around 650 nm) provides a good compromise between visibility to human eye and system performance; hence widely adopted.

Another aspect to consider choosing visible spectrum follows. Photodiodes normally come in 2 options, with daylight filter and without daylight filter. The ones with a daylight filter have poor response to a visible wavelength which cannot be used in systems needing visible wavelength; however, the filters restrict ambient light significantly – especially sunlight which has a very broad spectrum, improving ambient performance by a great deal. In that aspect, choosing a visible spectrum means that system has to deal with higher ambient conditions compared to invisible-spectrum systems.

4.3.1.2 Invisible Spectrum

A target is oblivious to measurements made by a near-infrared (NIR) wavelength system.

Infrared technology is widely confused as only having something to do with heat sensing. Although technically correct, the spectrum of infrared used to detect heat signatures is very different from the NIR with which ranging and ToF systems are built. Thermal infrared wavelengths range from 8 μm to 15 μm , called long-wave infrared which is used by passive infrared sensing. There are other short-wave and medium-wave infrared spectrums used in military applications. In all ToF-based systems, NIR universally means wavelengths ranging from 750 nm to 1400 nm.

Since NIR wavelengths are very close to the visible range, NIR emitters are still visible to the naked eye under dark enough circumstances. This is predominant with emitters around 850 nm. This may be unacceptable in certain applications where users are distracted. In such cases going deeper into the NIR spectrum helps, like moving to 940 nm for example.

4.3.2 Medium of Transmission

In most applications the medium is air, where the properties of transmission are the same in the wavelengths of consideration.

There are systems which might need to work in smoke or dusk where the properties widely differ.

4.3.3 Eye and Skin Safety

Eye and skin safety standards are very dependent on the wavelength of operation. Based on the chosen wavelength, different aspects of safety measurements and safety analysis must be made to certify and classify the system.

4.3.4 Overall System Performance

After taking all aspects and constraints into consideration, if a wavelength still must be chosen, one needs to choose a combination of emitter and photodiode that have matching peak sensitivities.

4.4 Target Type

It is important to understand the type and characteristics of the target to be used before the system design.

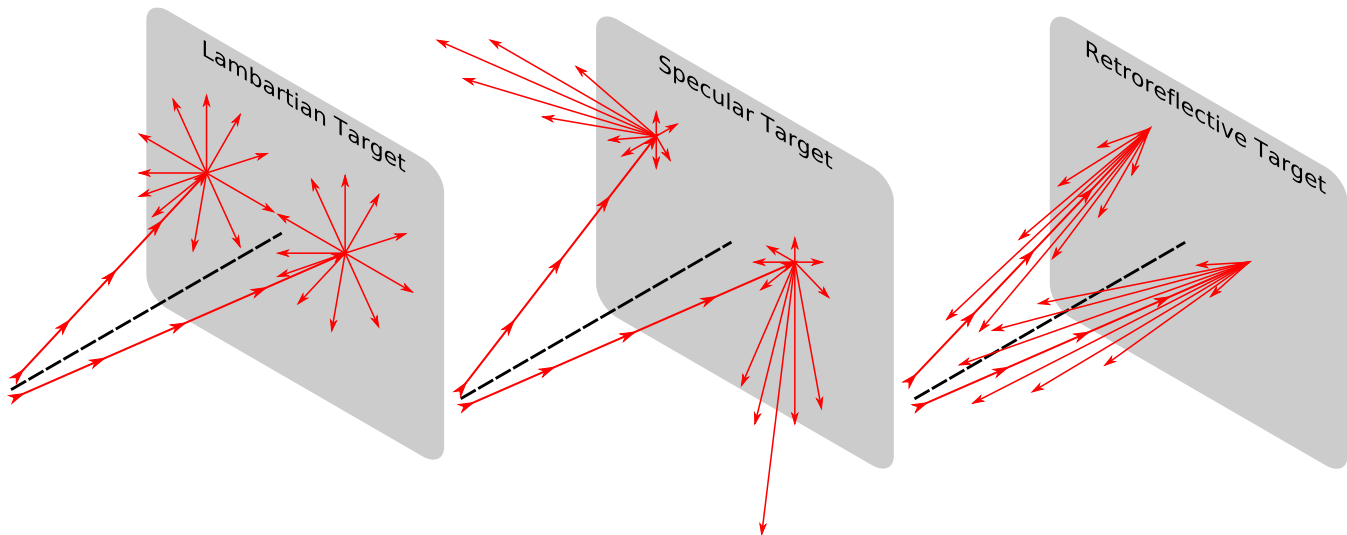

Figure 8. Type of Targets Based on Reflectance

4.4.1 Lambertian Reflectance, Diffused Reflector

These are targets which diffuse light falling on them from all directions. Examples of Lambertian reflectance are matte finish paper, cloth, and human skin. These are much easier to deal with since the light cast on the target is evenly distributed in all directions making the system immune to the angle and position in which the target lies. For example, an autonomous robot having an OPT3101-based system for collision avoidance is able to sense walls reliably independent of the angle of the wall.

The reflectivity of the target expressed in ratio % is characterized by the ratio of the total amount of light reflected off the surface to the ratio of the light incident on the surface. White paper has a reflectivity of over 90% and black denim cloth has a reflectivity of approximately 10%.

A simple way to check if the target is Lambertian or not is to take the target and point a laser pointer at it in a dark room. The reflection pattern from the target should be even throughout the hemisphere of reflection (2π steradians).

4.4.2 Specular Reflector or Shiny Reflector

These are shiny reflectors which behave like mirrors. Light cast on them is reflected as per laws of reflection based on the incident angle. There are strong and weak specular reflections. Strong specular reflectors are closer to mirrors, not having any diffusion in the light cast on them whereas weak specular reflectors also diffuse light along with mirror-like reflection. Good examples of strong specular targets are polished metal surfaces and mirrors. Examples of weak specular targets include brush-finished metal, glossy-painted walls.

Strong specular targets cause problems with ToF systems:

- They do not return the signal back to the system, hence, causing much lower system performance
- Shiny specular targets (like mirrors) trick the system based on the angle at which the emitter light falls on the target:
 - In some cases, a shiny specular target tricks the system to believe that, instead of the surface itself being the target, it makes the reflected scene seem to be the target.
 - In some cases, saturating the system by returning too much light back to the photodiode

A simple way to check if the target is specular or not is to take the target and point a laser pointer at it in a dark room. The reflection pattern from the target should contain a strong blob of reflection as per the expected reflected angle and a cloud of reflection around the same, based on how specular the target is. The ratio of intensity between the strong blob and the cloud of reflection around it help determine how specular the target is.

4.4.3 Retroreflector

These are special types of reflectors which return the light cast on them at the same angle as that of the incident light. These are particularly useful in extending the range of the ToF, if these could be used as targets. Examples of retroreflectors that can be found in real life are: stickers and boards used in highway signs, safety stickers on vests or helmets of bike riders.

In some systems where targets are controlled, these make excellent targets since they contribute to most of the reflected signal as compared to other types of objects in the FoV. This helps make reliable long-range detection with much lower power.

A simple way to check if the target is a retroreflector is to take the target and point a laser pointer at it in a dark room. The reflection pattern should be cast at the same angle as that of the source. There is minimal dispersion based on the quality of the retroreflector.

4.5 Target Distance

Specified as the distance where a particular performance target needs to be met. This critical parameter needs to be decided early on in the system design phase, primarily driven by the application. The OPT3101-based systems are capable of operating over a wide range of target distances (from a few mm to 10s of meters) based on component selection and optics design. Performance of the system is a strong function of the target distance. For example: at 2 times the target distance the noise performance of the system scales by 4 times (follows a square law).

4.6 Dynamic Range

This is represented by the range of operating conditions for which the OPT3101-based system is expected to operate without losing performance target and saturation. This is mainly governed by:

- Distance range:
 - If the system is expected to work from 100 mm to 1000 mm, then the dynamic range required is 100 times or 40 dB (follows square law for distance).
- Reflectivity range:
 - If the system is expected to work for both 5% reflectivity target and 95% reflectivity target, then the dynamic range required is 19 times or 25.6 dB

If both the previous conditions must be met, then the dynamic range requirement for the system is $100 \times 19 = 1900$ (expressed in ratio of maximum to minimum) or when expressed in decibels – it is 65.6 dB.

The OPT3101 AFE system offers a finite dynamic range, available in [OPT3101 Long Range Proximity/Depth Sensor AFE](#). Techniques to improve the dynamic range using the HDR and super HDR functions are covered in the data sheet.

4.7 Performance Target

Some important things to understand before specifying the performance target are listed in this section. The performance target is always specified at the following:

- Particular distance
- Given data rate
- Particular reflectivity
- Given ambient level

A good performance target specification example follows:

- System at 2-mm noise
- 1000 mm
- 90% reflectivity target
- 130-kLux sunlight
- 5-mm error at 100 sps

The more conditions listed in the performance target, the clearer the specifications are to designing the system.

[Figure 9](#) and sections below explains the various performance parameters

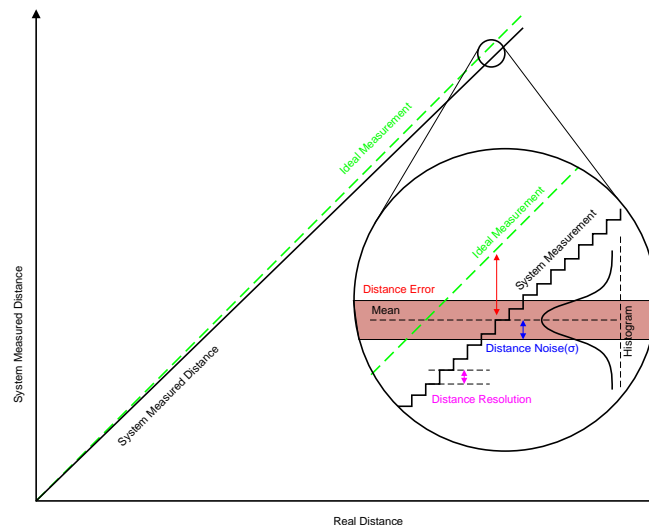

Figure 9. Performance Target Definitions

4.7.1 Distance Resolution

This is defined as the minimum possible distance that can be resolved by the OPT3101-based system. This is predominantly limited by the number of bits used to represent the distance which is 16 bits representing approximately 15000 meters at 10-MHz modulation with air as the medium. This corresponds to 0.22 mm per bit. The system is not able to resolve distance changes lower than this. Theoretically, it is possible to take more measurements and average them on the host controller to get sub-resolution measurements.

This is independent of the system operating condition and an artifact of the AFE architecture.

4.7.2 Distance Noise (σ)

This is defined as the standard deviation (σ) of the measurements over a set of samples taken over time. The larger the sample size, the better estimation of σ . This is highly dependent on the system operating condition.

Represented in mm, this is one of the key target specification inputs for the system design. Normally a noise is specified for a particular operating condition.

4.7.3 Distance Error/Accuracy

This is defined as the difference between actual target distance and the measured distance presented by the OPT3101-based system. This does not include distance noise and truly represents the offsets and drifts. This is highly dependent on the system operating condition, calibration completeness, and PCB design. There are several aspects which contribute to the error that are explained below

4.7.3.1 Error due to Residue Crosstalk

Crosstalk is defined as the unwanted signal sensed at the input when no signal is expected. Restated, it is the signal measured by the OPT3101 system when the target is far enough to reflect any signal back or the photodiode or LED covered. Although crosstalk and crosstalk temperature variation is compensated in the system as part of calibration, there could be variation in crosstalk due to second-order effects. This leaves uncompensated crosstalk (residue crosstalk). Residue crosstalk appears as a distance error which is explained in [Section 8.1](#). The effect of residue crosstalk is predominant at lower signal levels.

4.7.3.2 Error During Thermal Settling

ToF systems have temperature compensation which corrects for phase shifts in the system when the temperature of the system changes. Based on the thermal time constant of the PCB, there could be times when the PCB is transitioning to reach the stable temperature and the compensation could have residue, causing an error in the distance determined.

4.7.3.3 Errors due to Residue From Compensation

OPT3101-based systems have various different calibrations and compensations listed in the system calibration document. These compensations correct for all the non-idealities of the system to a great degree; however, there could be residues due to second-order and third-order effects. This appears as distance errors.

4.8 System Power

System power is a combination of the power consumed by the AFE and the power consumed by the emitter. The OPT3101 device is a flexible AFE which can be operated in various different modes of operation to achieve the desired power goals. Details of the same are found in [OPT3101 ToF based Long Range Proximity and Distance Sensor AFE](#). The following sections present some things to keep in mind while designing the system for a given power target.

4.8.1 Number of Power Supplies Available

The OPT3101 device requires many supplies, as listed in the data sheet and supports modes where all supplies could be tied to 1.8 V, all supplies could be tied to 3.3 V, or a combination of both. This has a strong impact on the system power consumption.

4.8.1.1 Only 3.3-V Supply Available

TI recommends using the OPT3101 in internal-LDO mode. This is not the best option in terms of power consumption, since the current draw for the 1.8-V supply comes from 3.3-V supply and the power gets wasted in internal LDO to drop out the voltage.

4.8.1.2 Only 1.8-V Supply Available

This is the best option in terms of power consumption; however, there is reduction in ambient current support, details of which can be found in the data sheet. Note that the emitter anode still must be connected to a higher supply, based on the forward voltage and the voltage required on the TX0, TX1, and TX2 pins to meet the bias requirements as per the data sheet.

4.8.1.3 Both 1.8- and 3.3-V Supplies Available

If 1.8 V is generated using an LDO exclusively for the OPT3101 AFE, there is no point in using an external LDO and TI recommends using the internal LDO. If 1.8 V is generated using the DC-DC converter, or is readily available, then using both the 1.8-V and 3.3-V supplies to power the OPT3101 AFE provides the most optimal system power.

4.8.2 Data Rate and Activity Factor

Data rate is typically specified as a system vector input for the design based on application need. For example: an ATM kiosk application may need to run at 5 sps. The activity factor is the ratio of time or duty cycle which represents the actual time the system operates to achieve the desired performance. For example: 5 sps translates to 1 data every 200 ms.

Now it is possible to operate the system only for 50 ms within the 200 ms for actual distance gathering. The system can be configured to go to deep sleep the remaining 150 ms. This means that the activity factor is 0.25 or 25% duty cycle. The total power drawn can be calculated based on the active power and deep sleep power from [OPT3101 ToF based Long Range Proximity and Distance Sensor AFE](#). It is important to understand that the performance of the system is dependent on the activity factor for a given data rate. Naturally a higher activity factor would result in better noise performance of the system, since more device samples gets averaged.

4.9 Size

The size of the system is determined predominantly by optics. Generally, a longer range system demands a higher lens collection area making the system bigger. The actual relation and bindings between different parameters is covered [Section 7.5.1](#).

5 Photodiode Selection

This section provides guidelines for the factors that need to be taken into account to choose the appropriate photodiode.

5.1 Type of Photodiode

PIN photodiodes are recommended due to their responsivity and fast switching times.

5.2 Wavelength (λ in nm)

Photodiodes fundamentally respond to a large bandwidth of wavelengths (spectral bandwidth); however they have peak sensitivity only at particular wavelength. Photodiodes are best operated at that wavelength to reap the best performance, although not a strict requirement. The wider the spectral bandwidth of the photodiode, the more current it generates from sunlight or other ambient light posing a limitation to the system, hence, a photodiode with a built-in filter around the wavelength of interest helps improve ambient performance. There is no specific guideline in selection of the peak wavelength of the photodiode; however, this is more a system design requirement covered in [Section 4.3](#).

Normalized Spectral Sensitivity(Photodiodes)/Emission(Emitters) for components

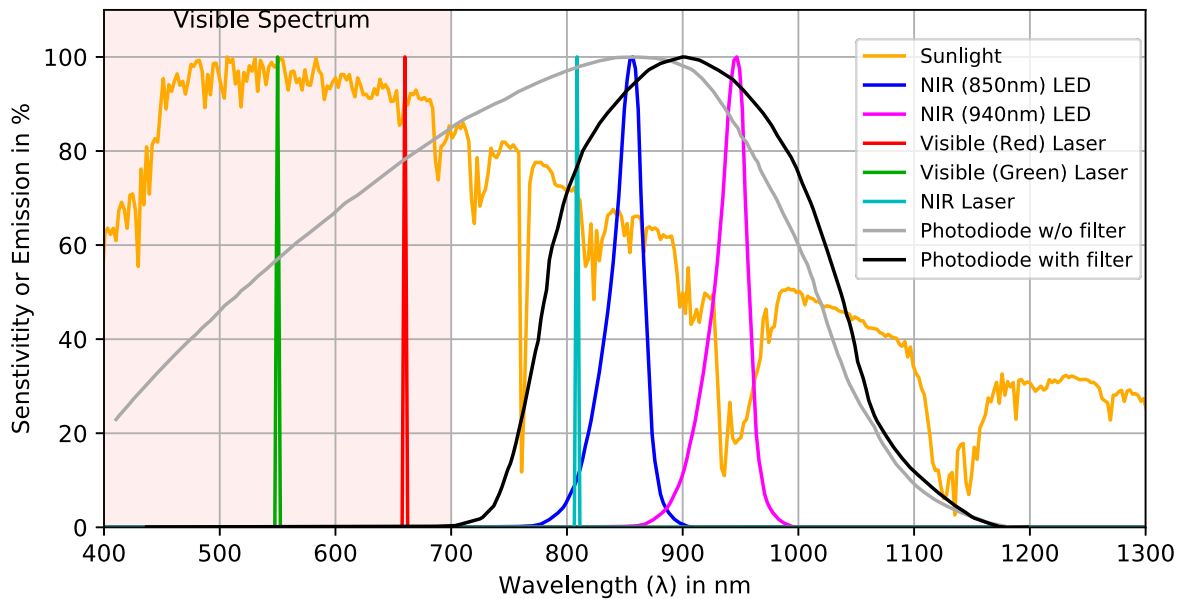

Figure 10. Spectral Response of Different Emitters and Photodiodes in Comparison With Solar Spectrum

5.3 Responsivity (Υ in A/W)

The responsivity of the photodiode is measured in A/W which determines the amount of current produced in Amperes for a given watt of monochromatic light (at a specified wavelength) thrown on to the photodiode. Variation in wavelength causes the responsivity to vary as per Figure 10. When a multi-chromatic light is thrown on the photodiode, the current generated is the integral of the multiplication of the spectral curves of the source and photodiode. This calculation is critical for ambient current calculation especially sunlight.

5.4 Radiant Sensitive Area (α in mm^2)

This area represents the photosensitive area of the photodiode. This determines the current generated from the photodiode given the W/m^2 light falling on the photodiode. In a lensless system, this directly determines the signal and ambient currents generated from the photodiode for a given illumination power. It is obvious that a bigger photodiode makes the system more sensitive; however, a larger photodiode also has higher junction capacitance, limiting the performance of the system. In the case of a lens-based system, this parameter is useful in determining lens focal length required for a given FoV and stack height requirement.

Larger photodiodes for the focal lengths and aperture of a given lens have a larger FoV, limiting ambient performance; however, also less prone to manufacturing tolerance problems with lens alignment.

5.5 Junction Capacitance (C_j in pF)

In an OPT3101 system the photodiode is reverse biased at a constant 1 V. Hence, the junction capacitance of the photodiode when reversed biased at 1 V determines the performance of the system. Figure 11 shows bias voltage vs capacitance of a typical photodiode. For this example it can be observed that it offers 6pF at 1 V bias. curve of a photodiode The current from the photodiode divides itself between the parasitic junction capacitance and the AFE input. Based on the coupling capacitor of the AFE and the photodiodes junction capacitance, the coupling loss is calculated. Data sheet has further details on this calculation.

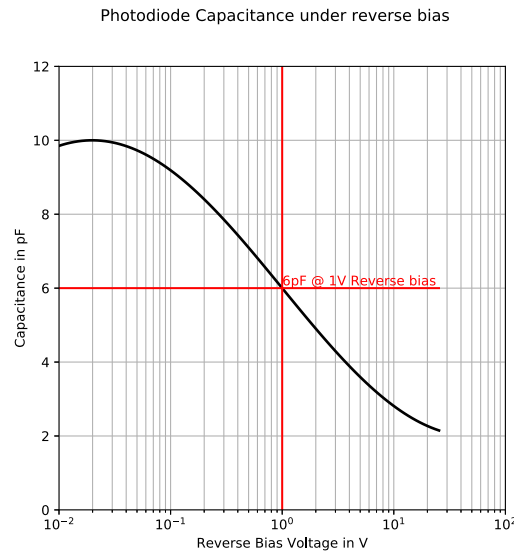

Figure 11. Reverse Biased Junction Capacitance Curve of Photodiode

5.6 Reverse Light Current

This parameter is a representation of responsivity, photosensitive area, and lens integration all taken into account. Some photodiode manufacturers prefer to specify this parameter rather than specifying individual components that determine this. This is typically specified as μA of current generated for a monochromatic light with $1 \text{ mW}/\text{cm}^2$ falling on photodiode. This current is typically specified for 5 V of reverse bias, however does not vary a lot when taken to 1 V, hence can be taken as it is which is reasonable.

$$\text{IrPD} = \text{Responsivity (A/W)} \times \text{optical gain} \times \text{Photodiode Area (cm}^2\text{)} \times 1 \text{ mW}/\text{cm}^2$$

optical gain = 1, in the *no lens* case (2)

5.7 Rise and Fall Times

The OPT3101 device operates at 10 MHz, hence photodiodes with rise and fall times $\leq 10 \text{ ns}$ are recommended. Choosing photodiodes with larger rise and fall times could mean loss in performance.

5.8 Lens Integration and Field of View

The lens on a photodiode improves the light collection ability of the photodiode for a given illumination power, thus improving performance. The ratio of the area of the aperture of the lens and the area of the photodiode determine the lens gain that can be achieved.

While the aperture of the lens determines the light-collecting capability of the system, the focal length and the distance between the lens and the photodiode determine the FoV of the receiver. With this in mind, some manufacturers offer photodiodes with lenses to improve the photodiode performance for narrow FoV applications.

Photodiodes without lenses have a wide FoV and have a response to angle of incident light as shown with curve corresponding to $\pm 60^\circ$ in [Figure 12](#)

However, some photodiodes come with an integrated lens which provides better reverse light currents than photodiodes without lenses but at the cost of reduced FoV.

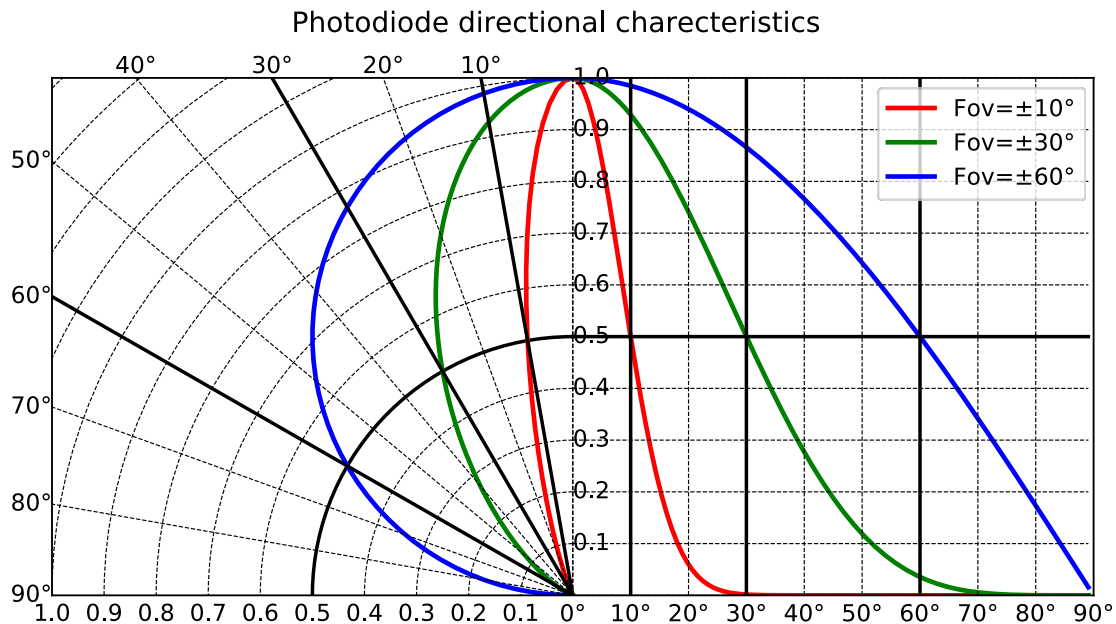

Figure 12. Angular Responses of Photodiodes With Varying FoVs

5.9 Package and Case Type Selection

Photodiodes come in various different packages and cases with different soldering options. SMD components tend to have profile height; therefore, better parasitic and crosstalk resilience.

Details regarding the same are covered in [Section 8.4](#). Based on the application requirements, side looking, gull-wing or through-hole photodiodes could also be chosen based on system requirements. Generally, photodiodes with smaller leads and a lower profile (height) tend to perform better.

6 Illuminator Selection

This section provides guidelines for the illumination component selection.

6.1 Type of Illuminator

The following sections cover the three major types of illuminators. Reasons are provided for choosing one illuminator among the other.

6.1.1 LED

LEDs are the most common and least expensive type of illuminator. LEDs are available in a wide range of wavelengths, power levels, and FoVs. LEDs tend to have lower efficiency due to light extraction loss and poor heat dissipation as compared to other illuminators. Since the light coming from the LED is not coherent and from a large surface area, these are extremely hard to collimate to a narrow beam. However, for application requirements larger than around a $\pm 3^\circ$ of FoV, LEDs are suitable. LEDs have robust construction, hence, have a better ESD performance and failure rate, and are therefore preferred for automotive applications compared to the other types of emitters. Depending on the power of the emitter, FoV LED certification and lamp source classification may be required.

6.1.2 Stimulated Emitters

6.1.2.1 Edge-Emitting Laser

Edge-Lasers are available for specific wavelengths and power levels from selected distributors. These are more expensive compared to LEDs, but have higher efficiencies. Light generated is coherent, from a small apparent source; therefore, can be collimated to a very high degree. For example, a laser source with a collimating lens can be focused to a beam as narrow as a few mm in diameter, maintaining its beam diameter to a distance up to several meters. However, high-power lasers could be harmful and have export control regulations and require additional certification (see [Section 6.2.1.4](#)). These emitters are very sensitive to ESD and overvoltage damage. Adding protection circuitry in the illumination circuitry extends system longevity.

6.1.2.2 Vertical-Cavity Surface-Emitting Laser (VCSEL)

VCSELs are similar to lasers, except their construction allows them to be highly-efficient emitters available at various different power levels. Sometimes VCSELs are custom made as per required specifications. Due to their physical construction, VCSELs have the highest-efficiency emitters available in the smallest form-factor packages. VCSEL light is coherent and may be collimated to a great degree, similar to edge-emitting lasers. VCSEL packages can also be designed to have specific diffusers as part of the package to achieve required intensity profiles. However, high-power VCSELs could be harmful to the naked eye; therefore, they have export control regulations and need additional certification (see [Section 6.2.1.4](#)). These emitters are very sensitive to ESD and overvoltage damage. Adding protection circuitry in the illumination circuitry helps system longevity.

6.2 Emitter Specification Parameters

6.2.1 Wavelength (λ in nm)

Depending on the emitter chosen, the emission characteristics vary. LEDs have a wider-spectral emission as compared to lasers and VCSELs, mainly due to the mechanism generating the photos. The center wavelength is a parameter typically specified in the emitter data sheet. Consider the topics covered in the following sections before choosing the center wavelength.

6.2.1.1 Visibility to Naked Eye

Some applications require a visual wavelength so the spot where the measurement is made can be spotted with the naked eye. For example: using an LED with approximately a 660-nm wavelength appears as a **red** spot, approximately 500 nm shows as **green**, and more than 850 nm appears with a faint **red** glow.

6.2.1.2 Medium Transitivity

Air typically has a similar transmission for a wide variety of wavelengths; however, applications requiring system operation in fog, smoke, or liquids must consider the transitivity of the medium while selection wavelength. For example, in fog higher wavelengths tend to travel longer distances as compared to lower wavelengths.

6.2.1.3 System Performance

Matching the center wavelength of the photodiode and emitter is crucial to get the best performance from the system. Choosing a different center frequency not only reduces performance but also reduces the signal to ambient ratio, maximizing which is important for high-ambient applications. Effective performance *Figure of Merit* multiplication of the wavelength response curves of the emitter and photodiode integrated over the wavelength of consideration.

6.2.1.4 Eye Safety and Certification

Eye safety certification limits are different for each wavelength. There are different lists of compliance checks and measurements based on wavelength chosen both for laser or VCSEL sources and LEDs. Hence while choosing center wavelength these parameters must be considered as well.

6.2.1.5 Interference to Other Systems

In certain situation it may be unacceptable to have modulating light sources at particular wavelengths which may interfere with other range detectors. In such a situation, choosing a distant wavelength to minimize interference helps systems coexist.

6.2.2 Radiant Intensity (mW/steradian)

The radiant intensity is specified for LEDs at a particular forward current. The dependency of this parameter on forward biasing is mostly linear; however, some LED manufacturers include a curve in the data sheet showing this dependency. A steradian is the solid angle cast by the light cone in the axis perpendicular to the emitter plane (measured in radians). 2π steradians means a hemisphere. For example: if an LED specifies a 500 mW/steradian at 100 mA, it implies that if 100 mA is pumped through it then it generates a light intensity of 500 mW per steradian near the center axis. If the entire hemisphere of emission is considered, the total power output should be $500 \text{ mW} \times 2\pi =$ approximately 3.14 W, which is not the case. There is typically a curve specified in the data sheet which shows how the radiant intensity drops off when moving away from the axis. The total output power ends up being significantly lower than the previous example. Radiant intensity (at the center) is typically higher for narrow-angle LEDs.

6.2.3 Half Angle (\pm degrees)

A half angle is an angle (2D Angle) measured from the axis perpendicular to the LED plane, where the radiant intensity drops to 50% of the peak radiant intensity (which is typically at angle 0) as shown in Figure 13. There are LEDs with special profiles where the zero angle does not necessarily have the peak radiant intensity. The following reasonable approximation to calculate the spot size of detection at various distances. For example: $\pm 10^\circ$ of system has a spot size of:

$$\text{spotSize} = 2 \times \tan(10^\circ) \times \text{distance} \tag{3}$$

The half angle proves to be a reasonable approximation, depending on the radiant intensity versus angle curve, the system responds to angles beyond the half angle, which is covered in Section 7.5.1 .

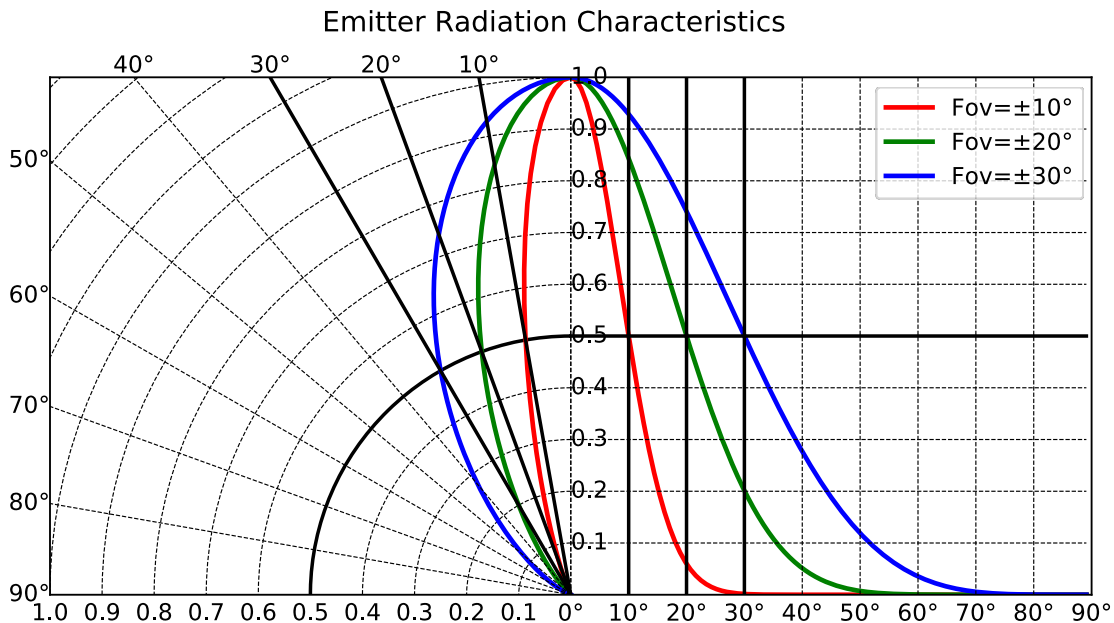

Figure 13. Angular Emissions of LEDs With Various FoVs

6.2.4 Total Radiant Flux (mW)

The total radiant flux is specified for LEDs at a particular forward current. This is a measure of power of all the light coming out of the LED. This can be used to calculate the efficiency of a photodiode.

$$\frac{\text{TotalRadiantFlux}}{(\text{Forward current} \times \text{Forward Voltage})} \times 100 \text{ gives the efficiency of the LED represented in \%} \tag{4}$$

Total radiant flux can also be calculated by integrating the radiant intensity over the solid angle from 0 to 2π .

6.2.5 Threshold Current (mA)

The threshold current is a parameter specified for lasers and VCSEL emitters. This is the current when the laser or VCSEL starts to give coherent light. With currents lower than the threshold current, the emitters behave like LEDs emitting widely divergent, non-coherent light. It is very hard to collimate the source to a small divergence angle under such operating conditions (as hard as collimating LEDs). Operating above threshold current ensures a highly efficient, coherent operation.

6.2.6 Beam Divergence (degrees)

Beam divergence is a parameter specified for lasers emitters. There are normally 2 values specified since the beam divergence from lasers are elliptical. This parameter is what is used to calculate the numerical aperture of the lens required to collimate the laser beam. There are many guidelines available to choose appropriate lens to achieve the desired collimation quality. The scope of that is beyond this document; however, numerous publicly-available materials explain this process.

6.2.7 Forward Current (mA)

Forward current specifies the rated current of the emitter with which the device can operate under DC operating conditions. Most of the properties like forward voltage and radiant intensity are specified when the rated forward current flows through the emitter.

6.2.8 Duty Cycle Thermal Limit

Although emitters are rated to operate at forward current under DC conditions, they actually run at higher peak currents under shorter duty cycles. The peak current to which they can operate safely is determined by the actual duty cycle of operation. This is specified as a graph in Figure 14. Careful study of this during selection of component is recommended. In the case of an OPT3101-based system, the operational duty cycle is 50%. This can be leveraged to select an emitter to maximize the system performance.

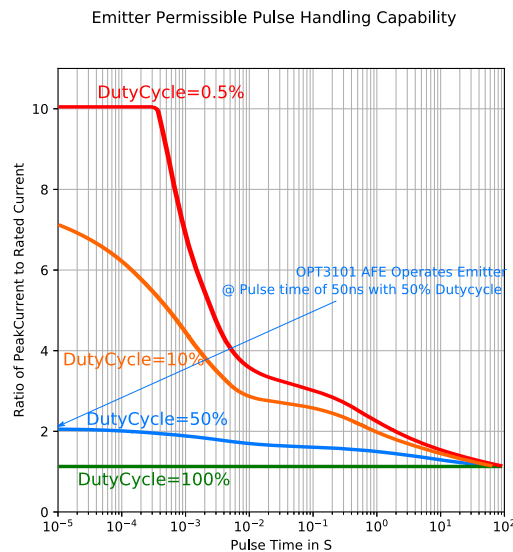

Figure 14. Duty Cycle Thermal Limit Curve for LED

7 Optics Design

Optics design is a crucial element in achieving the desired application functionality. It is prudent to understand the behavior of opto-electronic components and the optical system before designing the complete system including enclosures for a product. There are several aspects of optics design that need to be taken care of which are covered in this section of the document.

7.1 Calculations & approximations

In ideal ray optics simulations every ray needs to be solved and summed up for the overall system response. This is sometimes highly impractical and may not yield significant benefits over simpler calculations. To understand the reason why, it is important to understand the calculations behind ray optics.

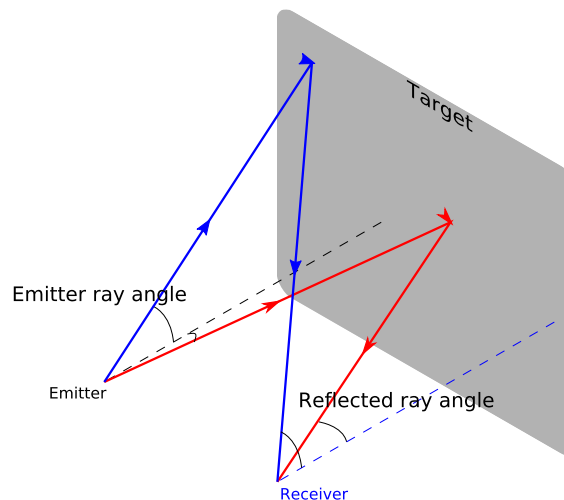

Figure 15. Ray diagram of transmit and receive light

In [Figure 15](#) there are only two rays from the optical system, taken in to consideration to illustrate this. Both the rays emerge from the emitter, get reflected by the target and reach the receiver. The key difference between the rays is that the red colored ray is at a narrower angle to the emitter and receiver whereas the blue colored ray is at a higher angle. There are key differences between the behaviors of the 2 rays.

- The intensity of the rays is dependent on the angle from which they come out of the emitter. This is based on the angular response of emitter like [Figure 13](#). One can see that the intensity is highly dependent on the angle. It is quite clear that the red colored ray would end up having higher intensity as compared to the blue colored ray, since the blue colored ray's angle is larger than the red colored ray's angle.
- The receiver similar to the emitter has angular dependency as well as shown in [Figure 12](#). It is quite clear in this case as well that the red colored ray would end up producing more photo current as compared to the blue colored ray (even considering same intensities)
- Assuming the target is a lambertian target, only a portion of the emitter light would get captured by the receiver. Blue colored reflected ray has to travel longer distance as compared to the red colored reflected ray, which would further be seen as reduction in intensity by photodiode.
- The receiver capture aperture or surface is normal to the axis of the receiver. Since the blue colored ray would be received at a higher angle than the red colored ray, there is an associated cosine angle loss as well.

As one can see there are several aspects that affect each ray based on the factors listed above. To get the most accurate representation of the system behavior, every ray has to be individually solved and summed up to get a good estimation.

It is also quite evident that higher angle rays end up having several compounding attention factors making them contribute lower to the photo current generation. This is one key reason why the performance of the system drops significantly when the field of view of the system increases.

Considering all these calculation are impractical for hand calculations hence a system estimator tool is available that solves and provides estimation for system performance based on all these aspects taken in to consideration.

In case of narrow field of view systems (especially less than $\pm 10^\circ$), there are several factors which can be approximated to lumped ray models and still get a fairly accurate system estimation using hand calculations.

7.2 **Optical Isolation**

Optical isolation between the emitter and receiver is crucial to achieve good system performance. Continuing on the explanation as the previous section, having any amount of light leakage from the emitter directly to the receiver could make the system unusable. Examples of such light leakage are as follows.

- Sub optimal design of optical isolation
- Poor material choice to isolate components
- Gaps in installation of optical isolation
- Poor cover glass design

To give a reference of power levels, in a typical OPT3101 based system the emitter powers are in the order of 10s of mW of optical power. Whereas the received optical power is receiver is few 100 pWatts to few 100 nWatts. Assuming isolation material is used for optical isolation with an attenuation of 1000 times, the signal leaking though the material would still saturate the system as compared to the desired signal from target as it would be few orders lower in power. Hence choosing the right component and designing the isolation is absolutely critical for system performance.

The following figures shows multiple implementation types with performance comparisons for flat and tapered cover glass designs.

- Type (a) in figure below is Dual cavity dual glass design: This is best performing system since the internally reflected light is completely blocked from entering the photodiode cavity. This would require 2 cover glasses pieces which may be impractical and may not be acceptable for some applications.
- Type (b) in figure below is Dual cavity single glass design: If (a) is not acceptable this is the next best option for the design. This provide a good amount of isolation between the emitter and the photodiode cavities
- Type (c) in figure below is Composite cavity single glass design: This is the least preferred of the design options which could create poor isolation between the cavities.

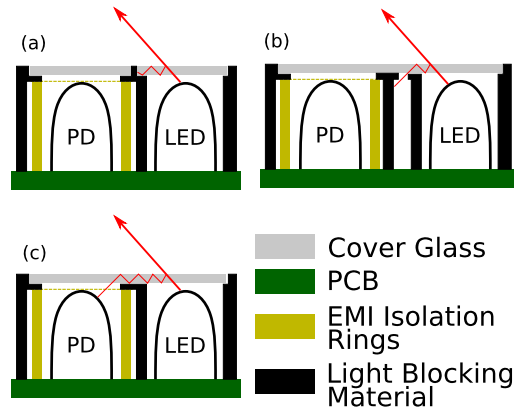

Figure 16. Cover glass design for flat cover glass

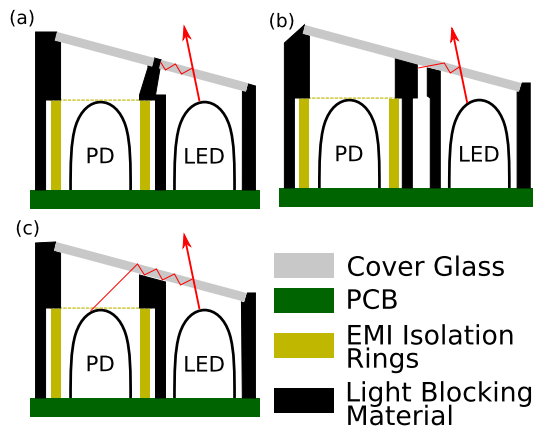

Figure 17. Cover glass design for angled glass

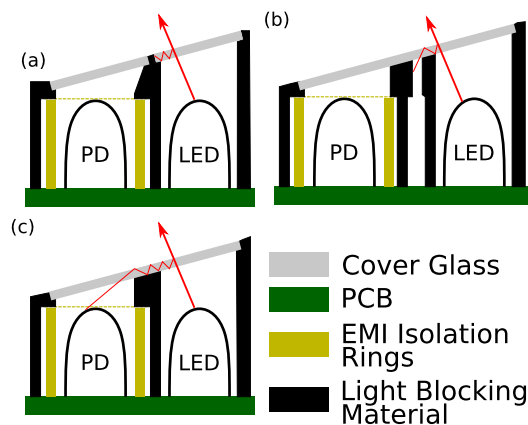

Figure 18. Cover glass design for angled glass

Given a choice among the tapered glass examples show above, [Figure 18](#) would be a better placement than the [Figure 17](#) since the photodiode aperture is not limited by the optical isolation structure.

A few 3D illustrations of the optical isolation structures are shown in [Figure 19](#).

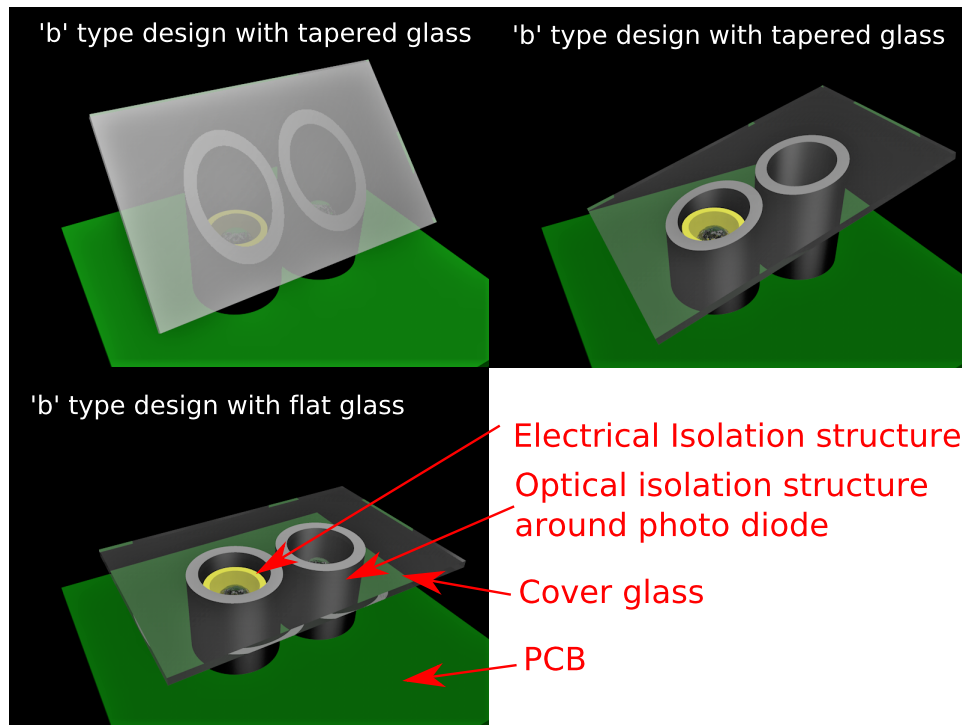

Figure 19. Dual cavity common glass 3D example

As shown in [Figure 19](#), these are examples of isolation and cover glass designs. There are a few other ways to implement these structures based on the requirements. This section sensitizes the user to understand the importance of isolation and the cover glass design. Intensive care should be taken to minimize light leakage which helps maximize the system performance. Optical transitivity loss of the cover glass needs to also be taken in to account during the system design. This is to compensate for the optical power attenuation.

7.3 Optical Aesthetics

Some systems desire the sensor to be hidden behind dark glass to make it oblivious to the user which is possible with systems using Near Infrared wavelength emitters and receivers. While choosing dark glass the following aspects need to be considered carefully.

- Wavelength response of the dark glass in visible region (to hide the system) and the wavelength region of interest (Near Infrared is typical case)
- Optical clarity and transitivity at wavelength of interest
- Dual glass vs single glass design as explained in the section above.

7.4 Emitter optics design

LED based emitters typically have integrated optics to extract light with desired field of view. Choosing such an emitter makes the emitter optics design a simple process. There may be no additional optical components or lens required.

VCSEL or Laser based emitters typically do not come with integrated optics and need lenses to collimate the beam to desired beam width and degrees of collimation. In some cases, lenses may also be added on top of the LEDs to collimate to a smaller angle than readily available LEDs. In all such cases optical analysis is required to choose the appropriate optical components to achieve the desired field of view characteristics.

Collimation tutorials with clear guides to choose optical components are widely available on the public domain. Popular websites which sell catalog lenses and optical components have tutorials and white papers on choosing lenses for collimation.

7.5 Receiver optics design

Receiver optics design has the most prominent effect on the system design and performance. In several applications, requirements of particular field of view constraints the optics design which tends to limit the system performance. This section covers details about the relation between aperture, focal length, field of view and system performance.

Some photodiode components come with integrated lens in which case adding another options or lens to the system would not help. In those cases the system performance is limited to the component optical properties specified in their datasheet. As a simple rule, based on the field of view of the component an equivalent lens properties can be calculated which is explained later in this section.

7.5.1 Receiver Lens

The first question one would encounter is the following. Is the lens required as part of receiver optics? Simple answer to that question is yes, it helps improve performance, except in cases where the field of view is large enough to diminish the improvement that the lens brings to the system.

7.5.1.1 Lens Aperture

Aperture of the lens determines the light collecting ability of the lens.

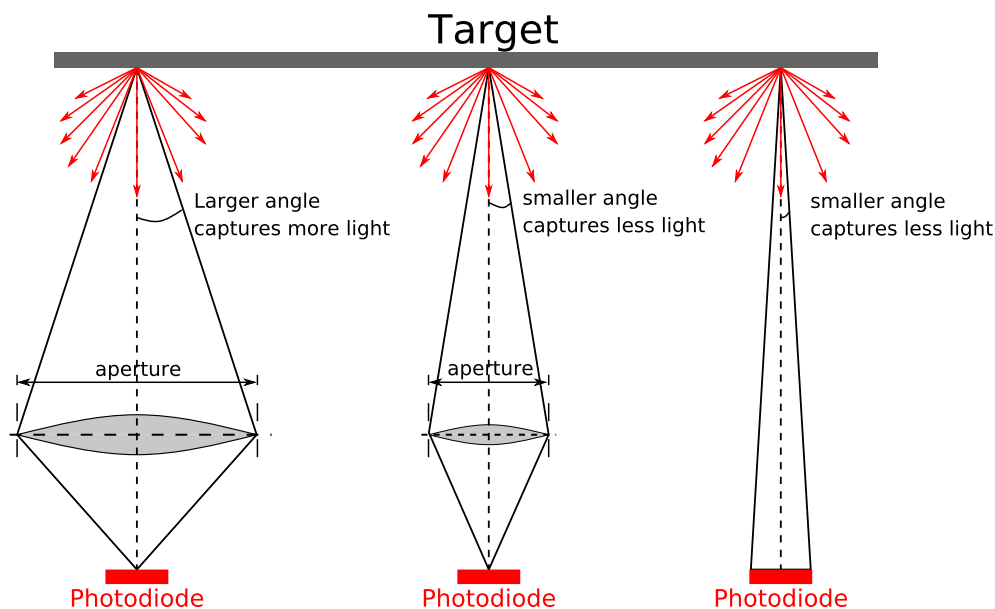

Figure 20. Receiver Optics with and without Lens

Consider [Figure 20](#) where the target is lambertian and is illuminated by a laser pointer with 1mW optical power. Assuming that the reflector is 100% reflective, the lambertian reflected light rays shown in the figure all add up to 1mW. In other words the 1mW power is distributed over all the rays that form hemispherical shape from the point of reflection. The amount of light captured by the photodiode now depends on the angle that the optical system forms with respect to the reflection point as shown in the figure.

There are three cases shown, 2 with lens and 1 without lens. The lens focal length (focusing ability) is exactly the same for both the lenses but the aperture (collecting ability) is different as shown. For a given target distance, it is quite apparent that the largest aperture lens collects the maximum amount of reflected light as compared to the smaller aperture lens which in turns collects more light than the case without a lens.

Another important aspect which needs to be understood in real life systems is that the aperture (few mm) is typically much smaller than the distance (100s to 1000s mm) to the target making the angles very small. Only a very small portion of the reflected power (in this example 1mW) is actually captured by the system.

Just to give a reference at about 1000mm distance with an aperture of 5mm only 6nW of optical power is captured by aperture as compared to the 1mW reflected by the target. If in case the aperture is doubled to 10mm the optical power captured becomes 25nW.

This can be calculated with the following formula

$$subtendedHalfAngle = \tan^{-1} \frac{\frac{aperture}{2}}{targetDistance}$$

$$lightCapturedByApertureAsRatio = \frac{(1 - \cos(2 \times subtendedHalfAngle))}{2} \tag{5}$$

This diminishes rapidly as inverse square of distance. This is the reason for the famous inverse square law considered in common literature in optics systems. Ratio of the aperture area to the photodiode area is called the optical gain. As one can see the optical gain increases as a square of the aperture diameter.

7.5.1.2 Lens Focal length

Focal length specifies the focusing ability of the lens. This parameter is what determines the field of view of the receiver system depending on the size of the photodiode. Another critical parameter that determines the field of view is the spacing between the photodiode and the lens.

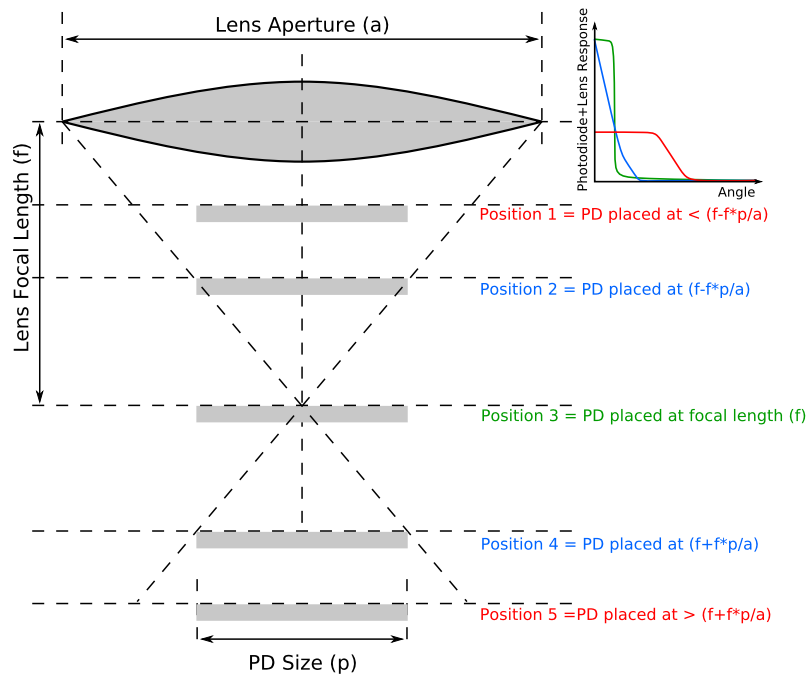

Figure 21. photodiode positioning from lens

The figure above (Figure 21) shows the sensitivity of receiver to the placement of the photodiode with respect to the focal length of the lens. Positions 2 to 4 yield the best performance. Other positions could provide optical gain, but not as much as one could get from placing them at positions 2 to 4.

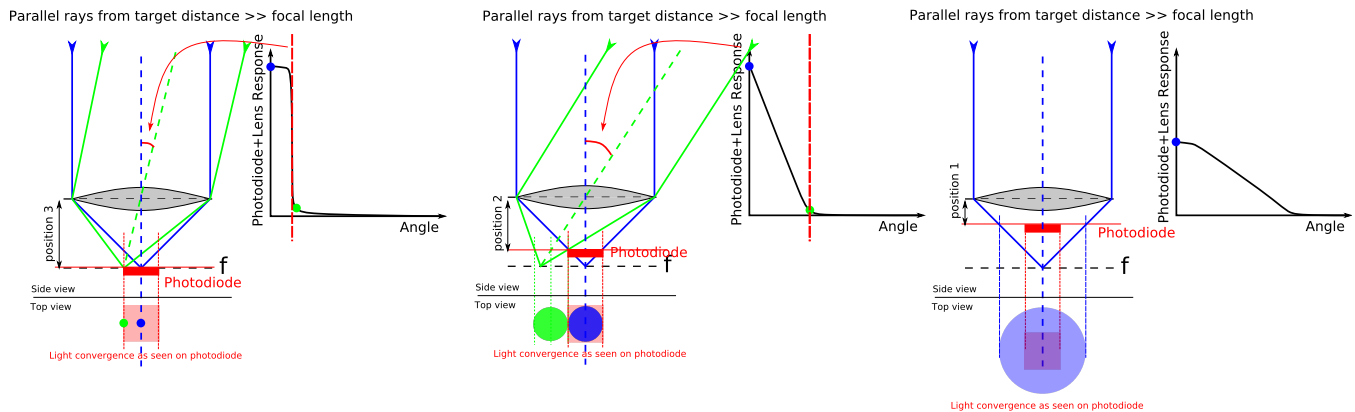

Figure 22. Thin lens ray optics diagram

Figure 22 shows a thin lens ray diagram for receiver optics. In this example the photodiode is placed at different positions to show the impact of the optical gain and field of view response curves. It is clear that the lens effectively focuses all of the aperture into the photodiode only between positions 2 and positions 4. In other positions, only portions of light gets captured at certain angles. Since at certain angles only light is captured partially, the overall optical gain drops reducing system performance.

The focal length of lenses (which is a few mm) are considerably smaller, than compared to the target distance (100s to 1000s mm). With this, we can assume that the photodiode is placed approximately at focal length of the lens which makes the calculations easier (as shown in the next section).

7.5.1.3 Pin hole model

Pinhole lens model serves as a quick way to calculate the field of view of a system given the photodiode size and the lens focal length. From the earlier sections, we could assume safely (with a reasonable approximation) that the photodiode is placed at the focal length of the lens. With a pin hole model for the lens, it can be seen that longer focal length lenses have smaller field of view.

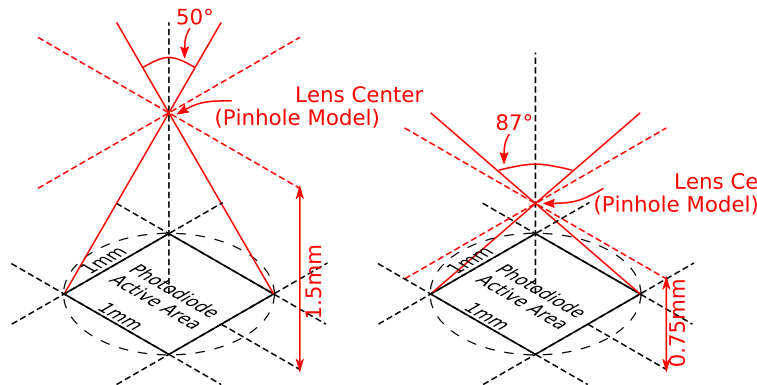

Figure 23. Field of View with pin hole model

Figure 23 shows an example calculation of a 1mm x 1mm photodiode with 2 different lenses (1.5mm focal length and 0.75mm focal length). In each case it shows that the field of views are very different (50° and 87°). It shows that larger field of view systems demand a lower focal length lenses. This requirement severely limits the performance of large field of view systems due to a fundamental limitations in lenses explained in sections below.

7.5.1.4 Relation between focal length and aperture

From the above sections it is generally desired to have a lower focal length (to cover wide field of view) and a large aperture to increase optical gain. In reality this is not possible due to fundamental limitations of lenses.

Let us consider examples from Figure 23. Assuming f/d of 1 the aperture of lenses with 1.5mm and 0.75mm are 1.5mm and 0.75mm, respectively. Based on previous calculations of optical gain it can be observed that the optical gain the 87° field of view system would be 4 times worst as compared to the 50° field of view system. The limitation is only due to the focal lengths being different and the f/d limitation.

It is worthy to note that to achieve very high field of view, the lens focal lengths have to be really small. In such cases the area of the aperture may end up being smaller than the photodiode area making the optical gain less than 1. In such cases it would be wise to not have lens on the photodiode.

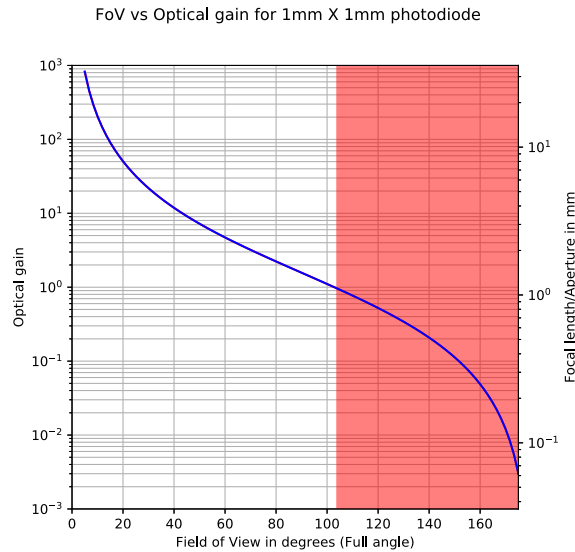

Figure 24. Field of view vs optical gain

The above figure shows for a 1mm x 1mm area photodiode and a lens of $f/d=1$, the optical gain and aperture/focal length plotted with respect to the field of view. Higher optical gains are achievable only field of views are narrow. The optical gain rolls off very quickly for higher field of view to the extent that it no longer makes sense to use lens for field of view greater than around 100° full angle ($\pm 50^\circ$).

7.5.1.5 Optical stack height

In previous sections we have already seen that placing the photodiodes at around focal length of the lens is what yields the best performing system. Stack height of the system now depends on the focal length of the lens used. Narrower system can afford longer focal lengths and aperture to achieve higher optical gain, at the same time making the receiver assembly taller.

Since these calculations involve thin lens equations, the actual stack height may be higher if the thickness of the lens and its assembly are included. Optical simulations are recommended before finalizing the industrial design for the system.

For photodiode components which include integrated lens, the data sheet of the component itself would specify the height of the component which determines the optical stack height.

7.5.2 Assembly alignment

There are a few aspects during system design to take in to account with regards to assembly tolerances. This is especially the case for narrow field of view systems.

7.5.2.1 Receiver and Transmitter field of view

It is always desired to have the receiver field of view slightly wider than the transmitter field of view depending on the separation between transmitter and receiver on the PCB. Simple two dimensional geometric calculations can be used to calculate the overlap required as shown in the figure below.

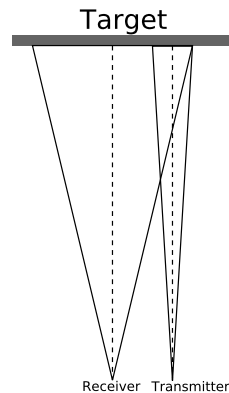

Figure 25. Field of view overlap

This also depends on the target distance range. Although field of views are considered as hard boundaries, in reality systems would respond beyond the field of view as well. This is mainly due to the field of view response curves of the optical systems do not have sharp boundaries. It could work to the advantage sometimes relaxing the field of view coverage requirement for nearby distances. In some cases, this may cause unexpected responses from nearby objects that are outside the desired field of view which can be avoided by careful enclosure design, like choosing non-reflective material for the enclosures.

7.5.2.2 Mounting tolerance

In case of lens based systems, placement and alignment of lens with the photodiode during assembly would affect the performance of the system. Narrower field of view systems tend to have more sensitivity to this than the wider field of view systems. During system design, it would help if these tolerances are taken in to account doing the photodiode placement, lens selection and industrial design for these systems.

7.6 Rules of trade offs

Here are some rules of tradeoffs that help scale and understand the systems performance under various conditions.

- Aperture effect on system performance:
 - 2X increase in lens aperture would...
 - translates to 4X signal power improvement; thereby, improving SNR by 4X
 - For a given noise and residue crosstalk, the distance range improves by square root of 4X which is 2X
 - For a given f/d would increase the focal length, hence, reducing the FoV for a given photodiode size (as per [Figure 24](#))
 - Increase the stack height by 2X due to focal length increase.
 - Would make mounting tolerance tighter due to smaller FoV
 - Reduce the FoV hence reduce ambient light collection
 - Would require the emitter optics to be tuned to reduce the FoV and contain within the receiver FoV
- Field of View effect on system performance
 - 2X increase in FoV requirement would:
 - Translate to reduction in lens focal length for a given photodiode size
 - Reduction in lens focal length would translate to a lower aperture for a given f/d
 - Reduction in SNR is the square of the ratio of the aperture reduction
 - Ambient collection increases due to higher FoV

- Optical stack height reduces due to smaller focal length
- Transmitter optics needs to be tuned to make the FoV larger to meet the 2X increased FoV (This would cause further loss in performance from the transmitter size)

8 PCB Design

OPT3101 AFE based optical systems require careful component selection, layout isolation to extract the best performance of the system. Designs are extremely sensitive to PCB layout, placement and component type. This section of the document explains the reason for the same and ways to mitigate it.

8.1 OPT3101 AFE Crosstalk

Crosstalk is defined as the signal detected by the AFE system when there is no target before the system. It could also be the signals detected by the AFE when the target is too far away to detect by the system. Crosstalk plays a critical role in determining the system absolute error and dynamic range.

Electrical crosstalk occurs due to electromagnetic coupling from transmitter or digital switching nets on the PCB to the analog side. Optical crosstalk occurs due to poor optical isolation or cover glass design. Optical crosstalk and assembly care about are as explained in [Section 7.2](#).

OPT3101 AFE is mainly sensitive only to switching nets of same frequency as the modulation frequency, namely the TX0, TX1 and TX2 pins, besides the grounds and supplies.

OPT3101 has various built in crosstalk correction capabilities outlined in the data sheet and calibration guides of the device. However it is important to minimize the crosstalk as much as possible to extract best performance from the system.

Even though there are several crosstalk correction features in the OPT3101 AFE, there could still be uncorrected crosstalk mainly due to temperature shifts, named residue crosstalk. Residue crosstalk is what really limits the system error performance.

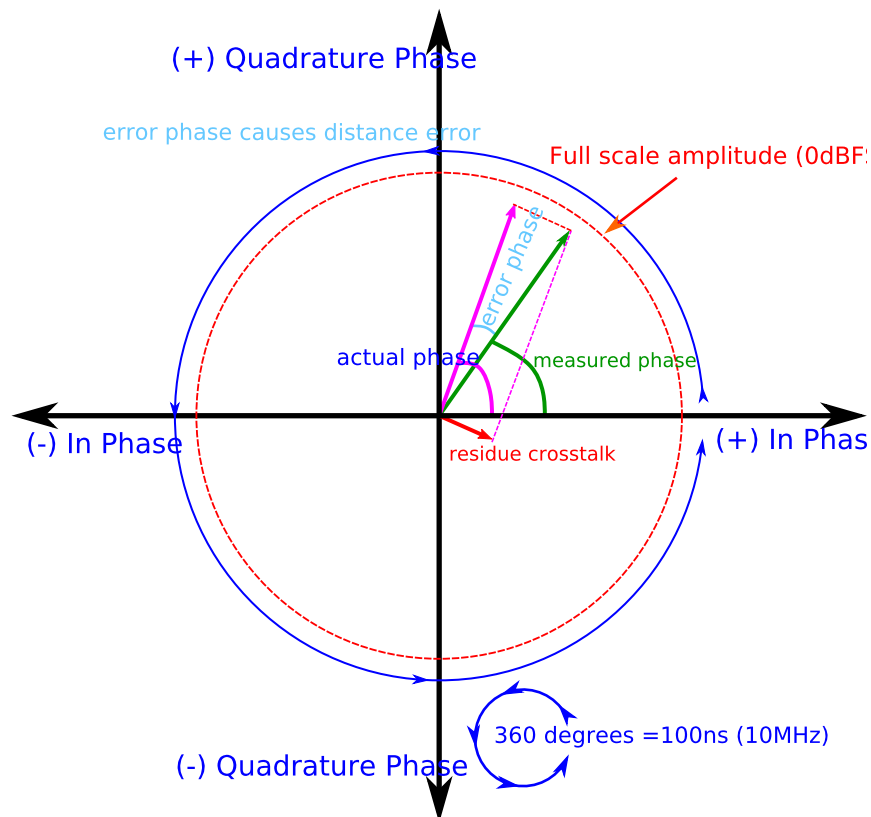

Figure 26. Vector diagram with residue crosstalk

Figure 26 above shows how and why residue crosstalk affects the system error performance. While reduction of residue crosstalk is important, residue crosstalk by itself is a strong function of the actual crosstalk being corrected. Hence it is all the more crucial to control and minimize the crosstalk. This section only talks about the PCB design and crosstalk mitigation techniques.

Crosstalk is measured in dbFS or codes of amplitude. With OPT3101 full scale amplitude is 32767, the crosstalk can be expressed in codes with reference to the full scale.

8.2 Power planning

OPT3101 is highly flexible with respect to power supply levels, however the analog and digital supplies have to be separated really well. The same rule applies to the grounds as well. There are 2 analog supplies, AVDD and AVDD3 both of which needs to be separated from the digital supplies DVDD and IOVDD.

The same rule applies for the analog grounds AVSS and IOVSS. There is a 3rd ground which is extremely noisy which needs to be handled differently as explained in later sections.

Four layer PCB is recommended for isolation and shielding. With lower number of layers, the layout gets extremely constrained making it difficult to design.

8.3 Aggressor and victim nets

OPT3101 AFE input nets INP and INM are high impedance nets suitable to electromagnetic coupling. There are 2 mechanisms of coupling that induces crosstalk, the voltage coupling and the current coupling. OPT3101 AFE is immune to coupling from other frequencies apart from the modulation frequency. Hence a ripple frequency from a DC-DC convertor or other clock frequencies on the board would not have significant impact to crosstalk, however even a small amount of coupling from the TX0, TX1, TX2 nets would increase the crosstalk several fold.

Victims are always INP, INM, AVSS, AVDD and AVDD3 nets. Aggressors are TX0, TX1, TX2, VSSL, Anode of emitters, IOVSS, DVDD.

8.3.1 Voltage coupling

OPT3101 AFE detects differential input between INP and INM pins as signal. Any direct parasitic capacitive coupling to the pins INP and INM would appear as signal to the AFE. Only if the coupled effect is equal for both INP and INM the coupling would get rejected as common mode. Hence its important to maintain symmetry between INP and INM pins. This is the reason for having matching capacitor on INM pins which match the capacitor value (at 1V which the AFE biases INP) of the photodiode connected to INP pin.

Common sources for voltage coupling are as follows:

- Switching TX0, TX1 and TX2 pins
- Noisy VSSL net (bouncing due to modulation frequency switching current)
- Anode nets of emitters. Even with good amount of de coupling capacitors, the anode of the emitters could have voltage swing which when not isolated could couple differentially between INP and INM.
- Poor isolation between analog and digital grounds could cause AVSS to have small voltage swing which could differentially couple between INP and INM.
- Poor ground isolation between analog and digital supplies could cause AVDD3 and AVDD to have small voltage which could differentially couple between INP and INM.

8.3.2 Current coupling

Photodiode and matching capacitor form a victim loop which is susceptible to magnetic current induction from aggressors. It is crucial to make the victim loop as flat (in 3 dimensions) as possible with minimal area to achieve best performance.

Common sources for current coupling are as follows:

- Switching TX0, TX1 and TX2 loops. TX pins could carry up to 173mA switching currents. Even with small aggressor loops the magnetic field from the aggressor would induce differential current in the

INP,INM victim loop. This would appear as crosstalk to the AFE.

- Decoupling loops from power supply source to decoupling capacitors especially for the emitters.

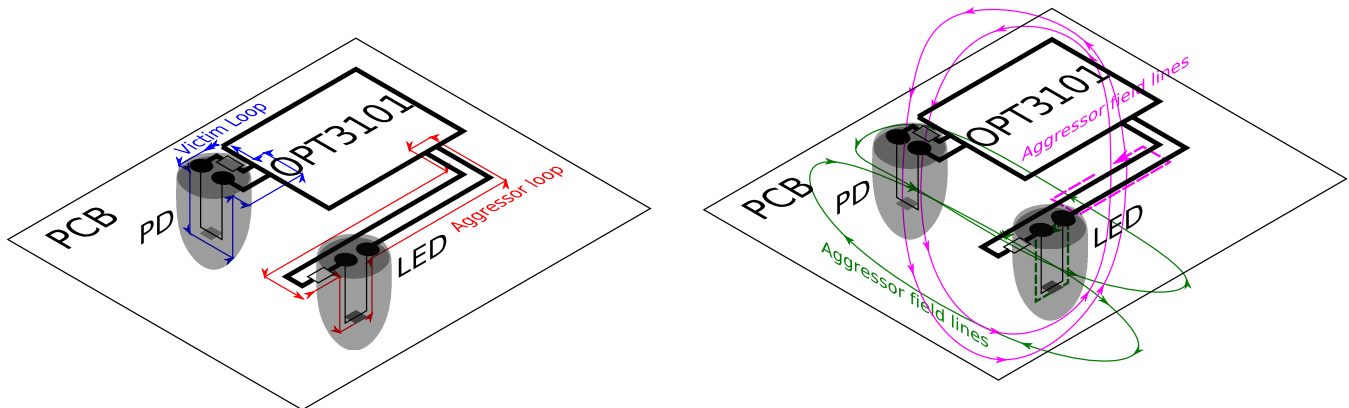

Figure 27. PCB Layout with magnetic field lines

The above figure shows a visualization of 3D loops formed in a through hole components based PCB. The through hole LED and through hole photodiode are placed in the bottom layer with OPT3101 placed in the top layer. The red colored loop is the aggressor loop and the blue colored loop is the victim loop.

How much ever one reduces the loop area in the PCB, the 3D loop is only determined by the lead length of the components, hence through hole components need 3D isolation structures beside all the layout guidelines. This is explained in detailed in [Section 8.5](#).

The magenta colored and green colored lines show the visualization of few magnetic lines emerging from the aggressor from different parts of the aggressor loop. Since each section of the loop has a different orientation in three dimensions, the field lines also behave and interact differently with the photodiode victim loop.

Due to the orthogonal placement of the LED and PD components, the green field lines would have minimal effect of the leads of the PD loop. The magenta field however would induce on to the PD loop on the PCB plane.

8.4 Active components selection

Although photodiode and emitter selection process is outlined in [Section 5](#) of this document, this section explains the selection criteria related to the crosstalk.

Since the device is sensitive to crosstalk choosing the right form factor components helps extract the best performance from the system. Typically components with shorter and close by leads help achieve lower crosstalk. For example the SMD photodiodes and LEDs have very short leads and spacing between the leads making them less aggressive when it comes to capacitive and inductive coupling.

Shorter leads act as smaller plates of capacitor minimizing voltage coupling. Shorter leads also act as smaller loops (since they don't protrude as much from the PCB plane) improving inductive coupling as well. Closer together leads also help reduction in the loop area.

For example, standard T1 ¼ through hole LEDs and photodiodes have leads which are 6mm long and spaced by 2.54mm. In comparison there are SMD photodiodes and LEDs which have lead length which is just 0.5mm and are spaced 3mm apart. In comparison the vertical loop area reduction is 6×2.54 compared to 3×0.5 which is around 10 times reduction.

SMD components are great for crosstalk but not a lot of options available with integrated optics thereby limiting the choice.

8.5 Electrical isolation structure

Even if utmost care is taken to improve the PCB layout, the lead length and the spacing make the loop area large and make the electrical crosstalk quite high reducing system dynamic range. Examples of such components are through hole LEDs and photodiodes. In such cases an electrical isolation structure which is connected to AVSS is recommended around the photodiode to isolate the photodiode from coupling.

It is recommended that the material has good electrical conductivity, magnetically inactive and soldered AVSS exposed pads on the PCB.

A common type of isolation structure is a ring. OPT3101 EVMs have such rings around the photodiode and the LED components. EVM rings are copper rings coated with ENIG (Electroless nickel immersion gold) for solder ability and aesthetics. Although required only around the photodiode, OPT3101 EVM has on both components for aesthetics.

In case of SMD components, isolation structures are not strictly required, but having ring around the photodiode would improve the crosstalk by a great extent

8.6 Passives selection

Decoupling capacitors and separation beads play a critical role in isolation of analog and digital sides. Since AFE is most sensitive to modulation frequency, beads and capacitor frequency responses have to be reviewed before making a choice. Ferrite core beads with high impedance (500 Ohms or more) at 10MHz is important for effective performance. Decoupling capacitors with low ESR at 10MHz would yield better decoupling.

8.7 PCB floor planning

Sectioning the PCB to analog, digital and transmitter sections help minimize coupling and crosstalk.

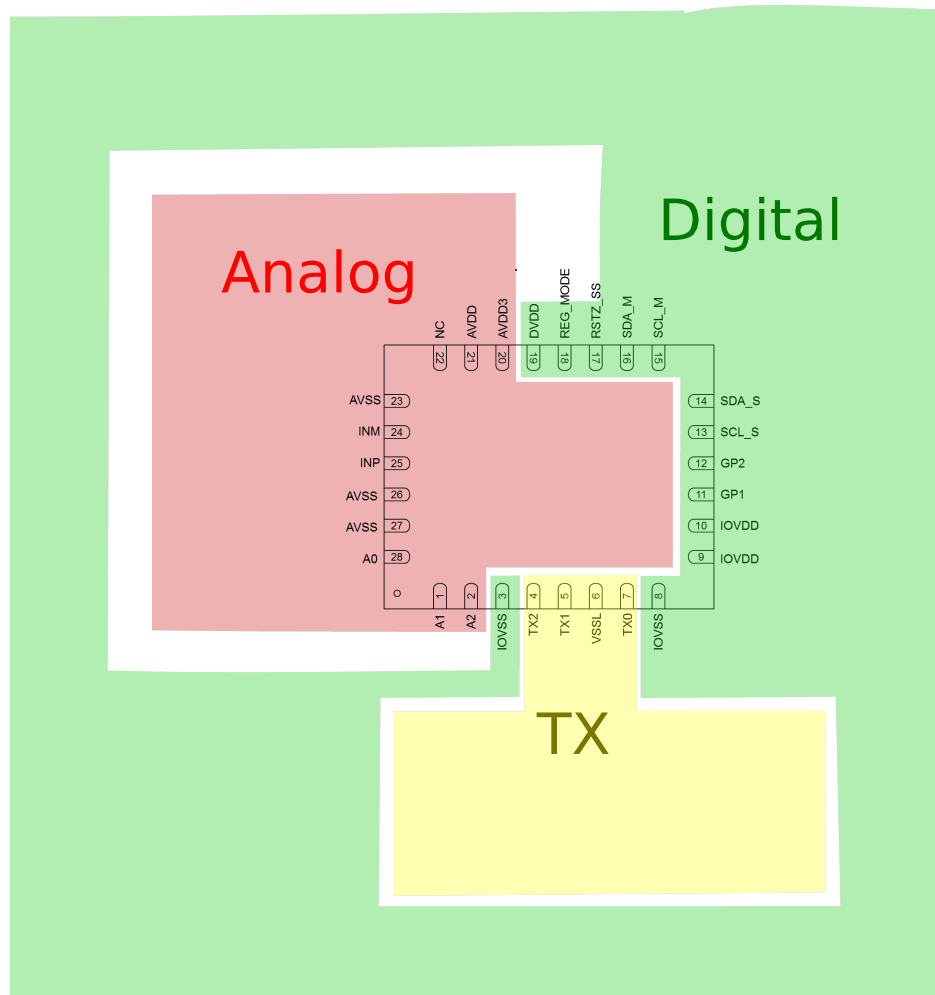

Figure 28. PCB sections recommended

Figure above shows the various zones to partition the PCB.

- Analog section:
 - All photodiode and input related components to be placed and routed in this section.
 - AVDD, AVDD3 decoupling capacitors to be placed in this section.
 - Isolation structure around the photodiode needs to be in this section soldered to the AVSS net.
 - All other layers to follow the same sectional with either AVSS, AVDD or AVDD3 related nets.
 - Recommended section with AGND vias around through hole photodiode components.
- TX Section:
 - This is high current generation section due to TX0, TX1 and TX2 channel loops.
 - Section needs special care especially isolation from the analog section.
 - Decoupling capacitor for the emitters to be placed in this section. Decoupling capacitors from emitter supplies are referred to VSSL net.
 - This section needs to be well shielded by IOVSS net around.
 - Except layer where OPT3101 AFE device is placed, other layers to have IOVSS for better shielding.
 - Bridge decoupling capacitor required from VSSL to IOVDD placed in this section.
- Digital section:

- All other IO related grounds refer to this section.
- I2C interfaces and other host IOs refer to this ground.
- IOVDD decoupling capacitors needs to be placed in this section.
- This could be common ground with rest of the PCB ground (host processor).
- All other layers to follow the same sectional with either IOVSS.

8.8 PCB Placement

Placement needs to be done in a way to optimize loop area, small route length for critical nets. It is highly recommended to follow the placement in the order as recommended below.

- Place OPT3101 device
- Place photodiode and matching capacitor as close as possible to the INP INM pins of OPT3101 device
- Place transmitters as close as possible to the TX0, TX1, TX2 pins so as to meet the optical housing constraints and industrial design.
- Place OPT3101, transmitter and the photodiode all on the same layer unless both photodiode and emitter are through hole components
 - If emitter and photodiode are both through hole components like OPT3101EVM then the OPT3101 needs to be placed in bottom later with the emitter and photodiode placed on top layer.
- Place the cathode of the emitter away from the photodiode to minimize capacitive coupling from leads of emitter cathode to the leads of photodiode
- Place through hole led and photodiode orthogonally (as shown in samples and OPT3101 EVM layout) to make the aggressor and victim loops orthogonal to each other
- Place decoupling capacitors for the emitters as close as possible to the emitter
- Follow floor planning section guidelines for placement of other components
- Keep in mind the spacing and solder mask opening required for electrical isolation structure.

8.9 PCB Routing and fills

- Input side
 - Route photodiode input loop with minimal area
 - Avoid VIAs on victim loop comprising INP, INM and AVSS nets.
 - INP and INM sides needs to be as symmetric as possible
 - Make single connection for AVSS side of the loop at a symmetric point
 - This would make the loop as differential as possible. It is highly recommended to make the loop an independent entity and just make a thin route connection from common point from AVSS net to the analog ground of the PCB. Some examples are shown later.
 - Fill AVSS at least 1 immediate layer below the input loop
 - Stitch AVSS connected vias around the loop for better isolation.
- Emitter side
 - Route the TX0, TX1 and TX2 lines as tightly coupled as possible to VSSL net or Anode of emitter. Close coupling ensures minimal loop area and voltage bounce.
 - In case of single transmitter channel avoid VIAs on TX net, VSSL net and anode of emitter.
 - In case of multiple TX configurations, VIAs are inevitable. VIAs on TX nets or VSSL are acceptable.
 - Shield these VIAs with IOVSS fills and VIAs
 - Use IOVSS to shield the TX and VSSL nets as much as possible
 - Use VIA stitching on IOVSS nets around the aggressor loop to shield them better
- Other routings
 - Once the critical nets are routed, other nets can be routed with remaining layers and space

8.10 Examples of good layout

This sections shows some good layout examples which achieve the best performance from the system

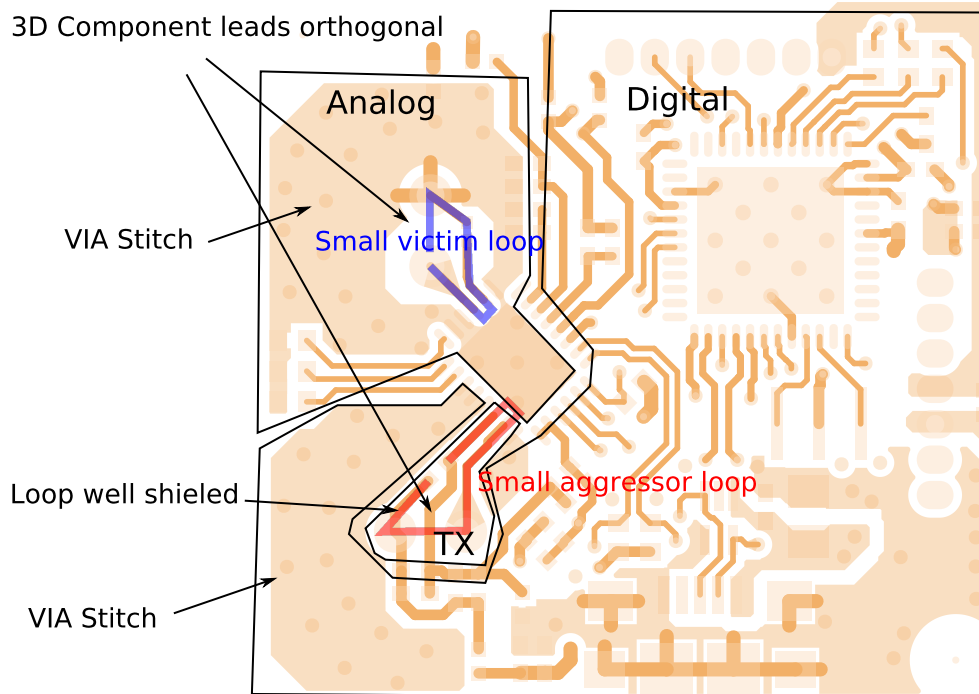

Figure 29. Good layout example 1

Example 1: OPT3101EVM Layout

- This is a 4 layer PCB with through hole LED and through hole photodiode
- PD and LED are placed orthogonal to each other in bottom later
- OPT3101 AFE device is placed in the top layer
- Analog, Digital and TX sections are separated well
- Aggressor and victim loops are very small
- VIA stitching for better isolation and shielding

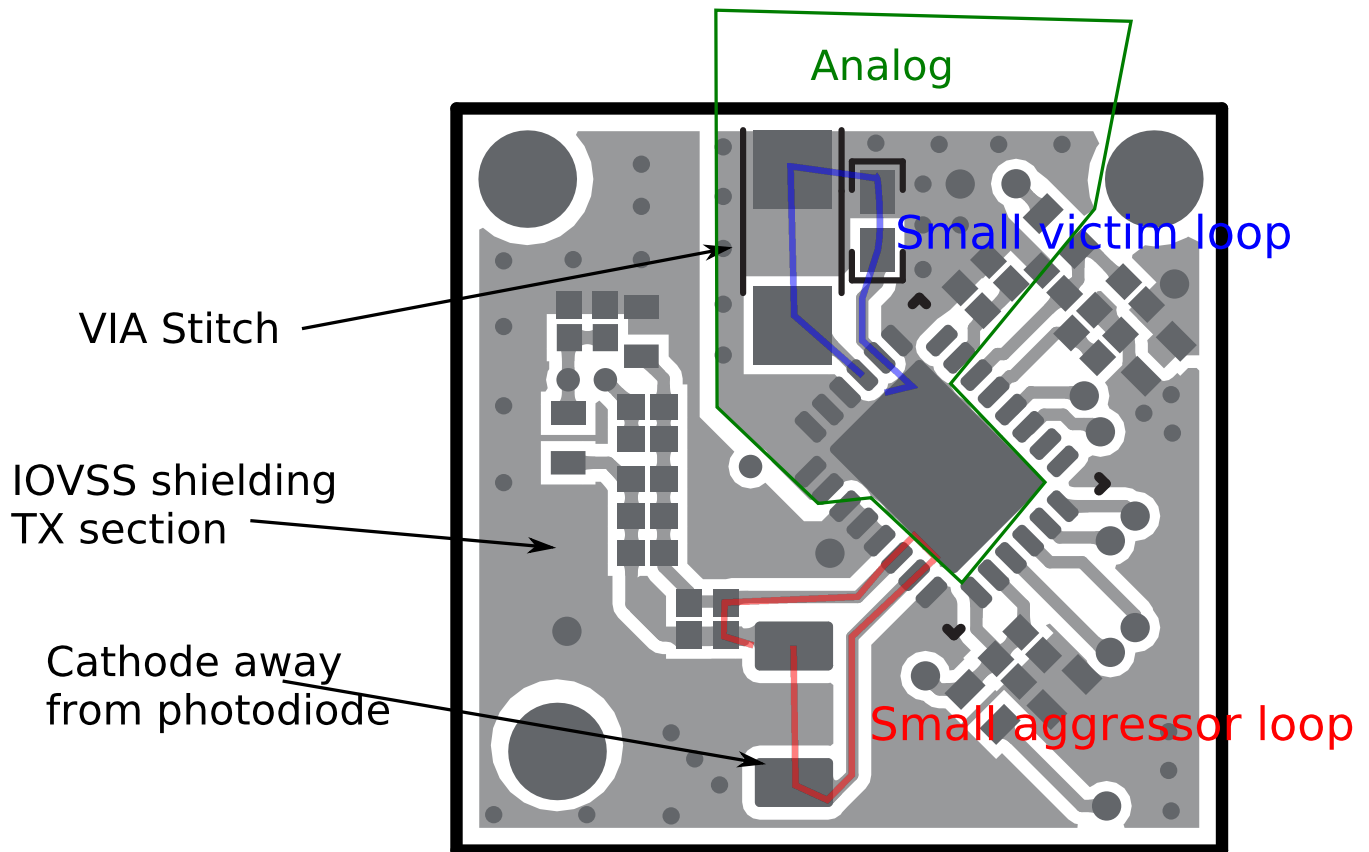

Figure 30. Good layout example 2

Example 2: SMD components PCB Layout

- This is a 4 layer PCB with SMD LED and SMD photodiode
- PD and LED are placed on top layer, in line with cathode of LED facing away from photodiode to minimize capacitive coupling
- OPT3101 AFE device is placed in top layer as well, avoiding VIAs on INP, INM and TX nets
- Analog section is clearly separated from digital section.
- IOVSS shields the small TX section and aggressor loop

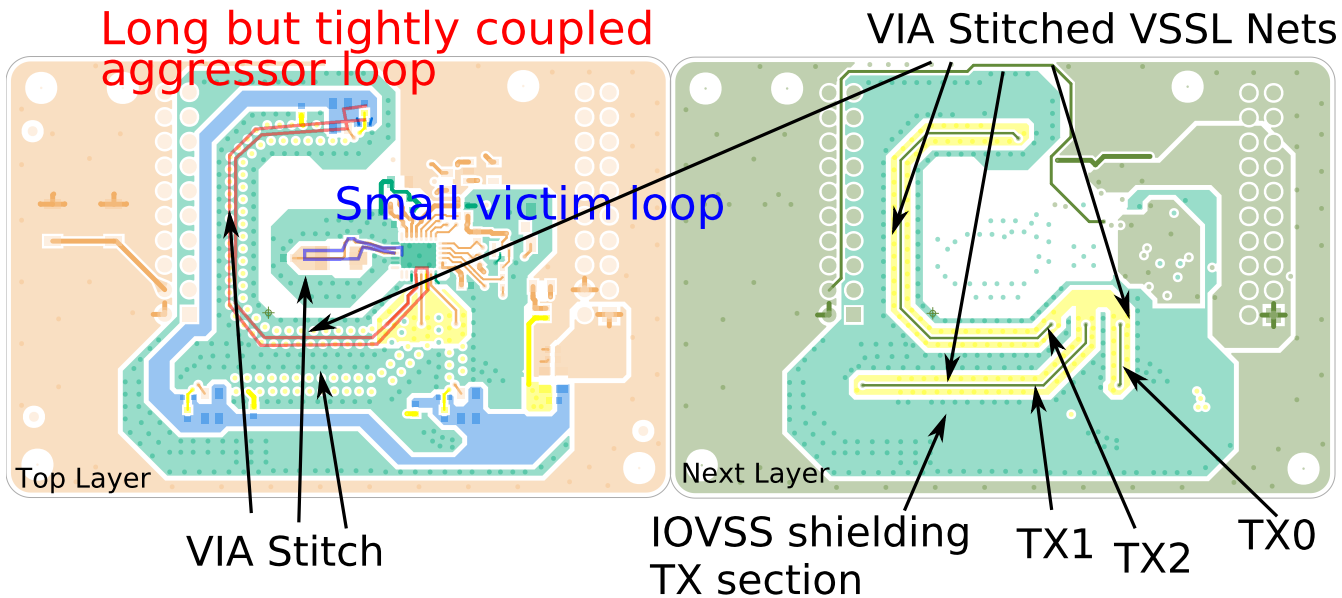

Figure 31. Good layout example 2

Example 3: Multi channel PCB Layout

- This is a 4 layer PCB with SMD LED and SMD photodiode.
- Layout has 3 LEDs placed at corners of a triangle with the photodiode in the middle of the triangle
- Although not marked in figure, the analog section is an isolated island in the layout
- Victim loop is small loop due to close placement between OPT3101 AFE and photodiode
- Aggressor loops cannot be small due to the physical placement requirement of the LEDs.
 - To minimize loop area, the loops have been made tight coupled between TX and VSSL nets with stitched VIAs.
 - The loops are then shielding by IOVSS nets with VIA stitching

Revision History

NOTE: Page numbers for previous revisions may differ from page numbers in the current version.

Changes from A Revision (June 2018) to B Revision	Page
• Changed <i>captures</i> To: <i>captures</i> in Figure 20	29
• Changed <i>Rule of thumb trade offs</i> To: <i>Rules of trade offs</i>	33

Changes from Original (March 2018) to A Revision	Page
• Changed from Advanced Information to Production Data	1
• Added a sample history element, for reference.	1

IMPORTANT NOTICE AND DISCLAIMER

TI PROVIDES TECHNICAL AND RELIABILITY DATA (INCLUDING DATASHEETS), DESIGN RESOURCES (INCLUDING REFERENCE DESIGNS), APPLICATION OR OTHER DESIGN ADVICE, WEB TOOLS, SAFETY INFORMATION, AND OTHER RESOURCES "AS IS" AND WITH ALL FAULTS, AND DISCLAIMS ALL WARRANTIES, EXPRESS AND IMPLIED, INCLUDING WITHOUT LIMITATION ANY IMPLIED WARRANTIES OF MERCHANTABILITY, FITNESS FOR A PARTICULAR PURPOSE OR NON-INFRINGEMENT OF THIRD PARTY INTELLECTUAL PROPERTY RIGHTS.

These resources are intended for skilled developers designing with TI products. You are solely responsible for (1) selecting the appropriate TI products for your application, (2) designing, validating and testing your application, and (3) ensuring your application meets applicable standards, and any other safety, security, or other requirements. These resources are subject to change without notice. TI grants you permission to use these resources only for development of an application that uses the TI products described in the resource. Other reproduction and display of these resources is prohibited. No license is granted to any other TI intellectual property right or to any third party intellectual property right. TI disclaims responsibility for, and you will fully indemnify TI and its representatives against, any claims, damages, costs, losses, and liabilities arising out of your use of these resources.

TI's products are provided subject to TI's Terms of Sale (www.ti.com/legal/termsofsale.html) or other applicable terms available either on ti.com or provided in conjunction with such TI products. TI's provision of these resources does not expand or otherwise alter TI's applicable warranties or warranty disclaimers for TI products.

Mailing Address: Texas Instruments, Post Office Box 655303, Dallas, Texas 75265
Copyright © 2019, Texas Instruments Incorporated