

MSP430FR6043-based ultrasonic gas flow meter

This guide provides an overview on how to get started quickly with the MSP430FR6043 MCU for gas flow meter solution based on ultrasonic technology.

Contents

1	Introduction	2
	1.1 Package Contents and Related Documentation and Tools	2
2	Hardware.....	2
	2.1 EVM430-FR6043	2
	2.2 Gas Pipe and Transducers	4
3	Software.....	5
4	Running the Application.....	5
5	Customizing the Demo	9
6	Flashing the Binaries	12
7	Troubleshooting	13
8	References	15
9	REACH Compliance	15

List of Figures

1	EVM430-FR6043-E2 Default Configuration	3
2	EVM430-FR6043 Connected to Gas-Flow Meter	4
3	Design Center in Disconnected State.....	6
4	Design Center in Connected State	7
5	Loading a Configuration	7
6	ADC Capture in Design Center	8
7	Waveforms in Design Center.....	9
8	Incorrect ADC Capture	10
9	Oscilloscope Connections for EVM430-FR6043-E2	10
10	Unadjusted Signal in Oscilloscope.....	11
11	Successful Execution of MSP Flasher	13
12	HID Bridge in Device Manager	13
13	eZ-FET in Device Manager	14

Trademarks

Code Composer Studio, E2E are trademarks of Texas Instruments.
IAR Embedded Workbench is a registered trademark of IAR Systems.
All other trademarks are the property of their respective owners.

1 Introduction

Thank you for your interest in the MSP430FR6043 kit for gas flow meters. This quick start guide reviews the documentation and collateral material relevant to the development of an ultrasonic-based gas flow meter solution using the MSP430FR6043. This guide also includes a step-by-step guide explaining how to run and customize the application and a troubleshooting section.

1.1 Package Contents and Related Documentation and Tools

- Hardware
 - [EVM430-FR6043](#): Development platform to evaluate the performance of the MSP430FR6043 for ultrasonic sensing applications.
- Software
 - [Ultrasonic Gas Demo Application for MSP430FR6043](#): This demo application uses TI's Ultrasonic Sensing Solution (USS) Library to implement a gas meter application. Communication with Design Center GUI allows developers to test and customize the performance of the application for different transducers and pipe characteristics. The demo includes source code and project files for Code Composer Studio™ IDE (CCS) and IAR Embedded Workbench® IDE (IAR).
 - [Ultrasonic Sensing Software Library \(USSLib\)](#): This library provides the means to configure the ultrasonic analog front end in MSP430FR604x devices and help to integrate it with the application software for development of ultrasonic sensing applications. The library includes libraries for CCS and IAR as well as a simple code example.
- Ultrasonic Tools
 - [Ultrasonic Sensing Design Center](#): PC application used to control the configurable parameters of the transducers and view the results including the delta time of flight (DToF), absolute time of flight (ATOF), measured flow rate, and ADC waveforms.
- Documentation
 - [EVM430-FR6043 hardware guide](#): Includes a detailed description of the EVM430-FR6043 features and supported configurations.
 - [MSP430FR6043 ultrasonic sensing design center user's guide](#): Explains usage and features of the Ultrasonic Sensing Design Center and includes a description of the USSLib parameters which can be modified by Design Center.
 - [Ultrasonic sensing software library documentation](#): Detailed documentation of the library APIs and configuration structures available in the library is available in the USSLib package.
- Additional Tools
 - [Code Composer Studio IDE \(CCS\)](#): Integrated development environment (IDE) supporting TI's Microcontroller and Embedded Processors portfolio. The software package included in this demo includes CCS projects.
 - IAR Embedded Workbench for MSP430 (EW430): Complete debugger and C/C++ compiler toolchain for building and debugging embedded applications based on MSP430 microcontrollers. The software package included in this demo includes IAR projects.
 - [MSP Flasher](#): Open-source shell-based interface for programming MSP430 microcontrollers.

2 Hardware

The following hardware is used by the MSP430FR6043-based gas meter demo.

- EVM430-FR6043 (see [Section 2.1](#))
- Gas pipe and transducers (not included) (see [Section 2.2](#))
- Fan with pipe connector (not included) (see [Figure 2](#))

2.1 EVM430-FR6043

The MSP430FR6043-based ultrasonic gas flow meter software package supports the EVM430-FR6043-E2 revision. The following sections show the configuration required to program, debug and execute the application.

2.1.1 EVM430-FR6043-E2

Figure 1 shows the EVM430-FR6043-E2, and Table 1 lists its default configuration.

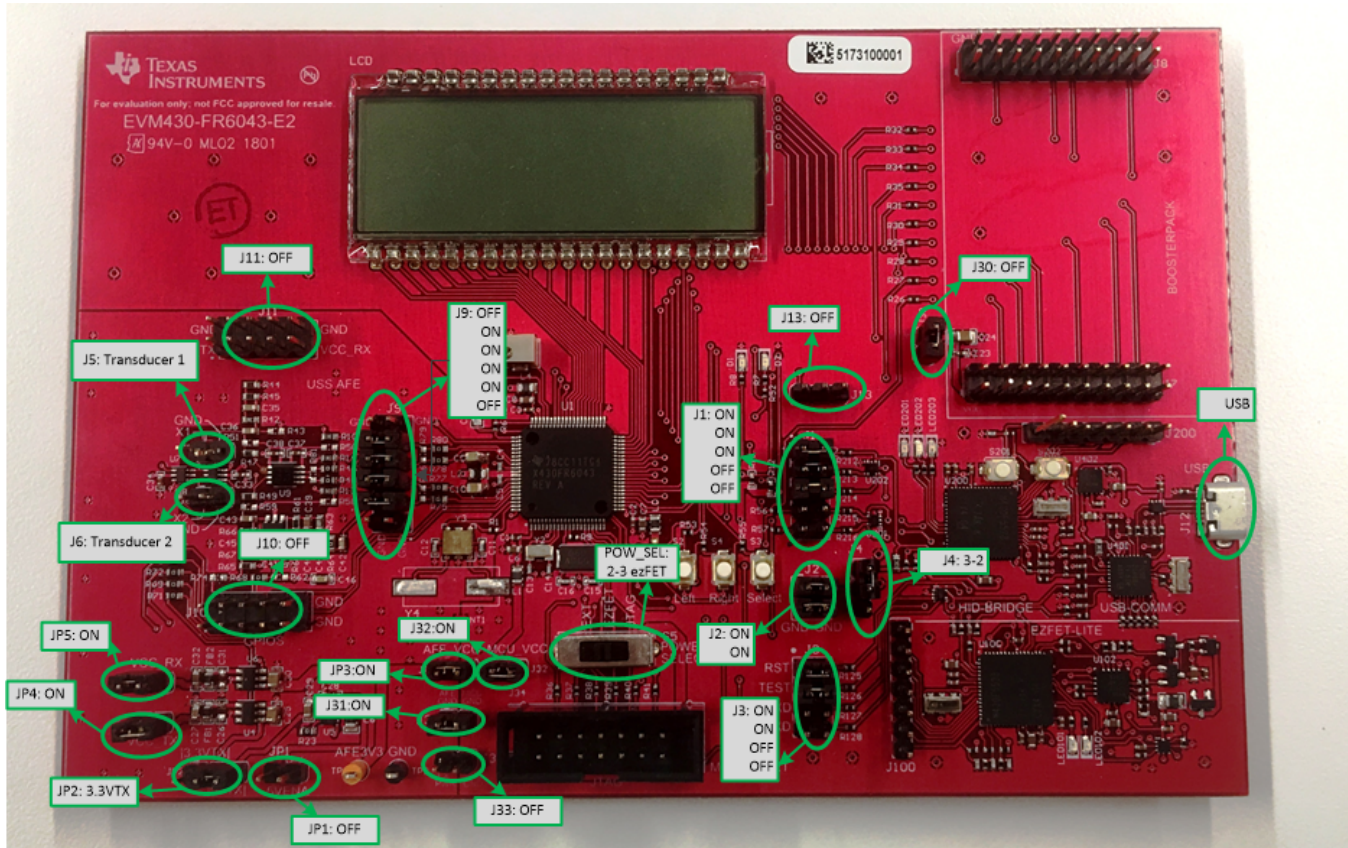

Figure 1. EVM430-FR6043-E2 Default Configuration

Table 1. Description of EVM430-FR6043-E2 Default Configuration

Jumper	Default Configuration	Description
J1	1-2: ON 3-4: ON 5-6: ON 7-8: OFF 9-10: OFF	Allows communication to Design Center using I ² C.
J2	1-2: ON 3-4: ON	Provides power to EVM from USB.
J3	1-2: ON 3-4: ON 5-6: OFF 7-8: OFF	Allows programming and debugging using integrated ezFET. Back-channel UART is disabled.
J4	2-3: ON	Uses USB LDO to provide power to the EVM.
J5	Transducer 1	Used to connect transducer #1.
J6	Transducer 2	Used to connect transducer #2
J9	1-2: OFF 3-4: ON 5-6: ON 7-8: ON 9-10: OFF	Connects transducer signals to Analog Front End (AFE).
J10	OFF	Provides access to AFE pins. Not used for this demo.
J11	OFF	Provides access to AFE pins. Not used for this demo.

Table 1. Description of EVM430-FR6043-E2 Default Configuration (continued)

Jumper	Default Configuration	Description
J13	OFF	Provides access to MTIF pins. Not used for this demo.
J30	OFF	VCC disconnected from expansion connector.
J31	ON	Connects AFE ground to MCU ground.
J32	ON	Provides power to MCU. Can be used for power measurement.
J33	OFF	Used to provide external power. Not used when powered through USB.
JP1	OFF	5V circuitry is not used. Provides power to AFE circuitry. Can be used for power measurement.
JP2	3.3VTX	Enables 3.3-V circuitry. 5-V circuitry is not used
JP3	ON	Provides power to AFE. Can be used for power measurement.
JP4	ON	Provides power to AFE transmit circuitry. Can be used for power measurement.
JP5	ON	Provides power to AFE receive circuitry. Can be used for power measurement.

The configuration shown in [Figure 1](#) and [Table 1](#) provides power through USB and allows communication to a PC with Design Center using I²C. See the [EVM430-FR6043 hardware guide](#) for more information on different configurations.

2.2 Gas Pipe and Transducers

The demo allows developers to use custom pipes and transducers by connecting them to the J5 and J6 connectors. A DC fan can be used to demonstrate air flow (see [Figure 2](#)).

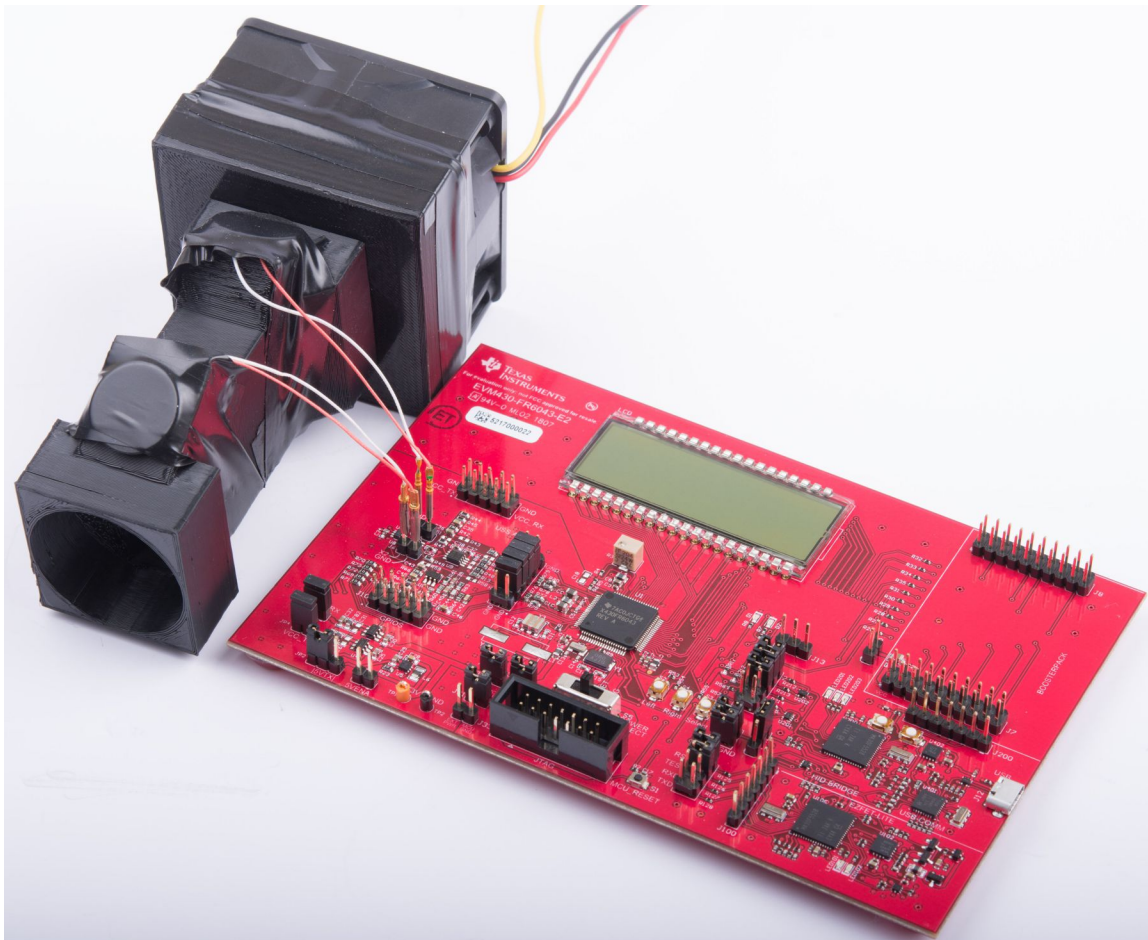

Figure 2. EVM430-FR6043 Connected to Gas-Flow Meter

3 Software

The gas meter application requires installation of the following software packages:

- [Ultrasonic Gas Demo Application for MSP430FR6043](#)
 - The example can be installed to the folder of your preference. By default, the application is installed to the following folder (the version of the code example might be different):
C:\ti\msp\UltrasonicGasFR6043_02_10_10_03
- [Ultrasonic Sensing Design Center](#)
 - Design Center can be installed to the folder of your preference. By default, this folder is as follows (the version of USS Design Center might be different):
C:\ti\msp\USS_1.71.02.02
- (Optional) [Ultrasonic Sensing Software Library \(USSLib\)](#)
 - The library can be installed to the folder of your preference. By default, this folder is as follows (the version of the library might be different):
C:\ti\msp\USSLib_02_10_10_02
- (Optional) [MSP Flasher](#)
 - Used to flash prebuilt application binaries. See [Section 6](#) for more details.

4 Running the Application

1. Set the EVM430-FR6043 to the default configuration (see [Section 2.1.1](#)).
2. The MSP430FR6043 is shipped factory-programmed and ready to run. If necessary, reprogram the device following the steps in [Section 6](#).
3. Connect the transducers to J5 and J6 on the EVM430-FR6043.
The order of the transducers is important only to determine the direction of flow.
If the transducers have polarity, connect the negative or GND cable to the corresponding J5 or J6 GND pin (see [Figure 2](#)).
4. Connect the EVM430-FR6043 to the PC through USB.

5. Open the *Ultrasonic Sensing Design Center*.
Design Center launches in the disconnected state (see [Figure 3](#)).

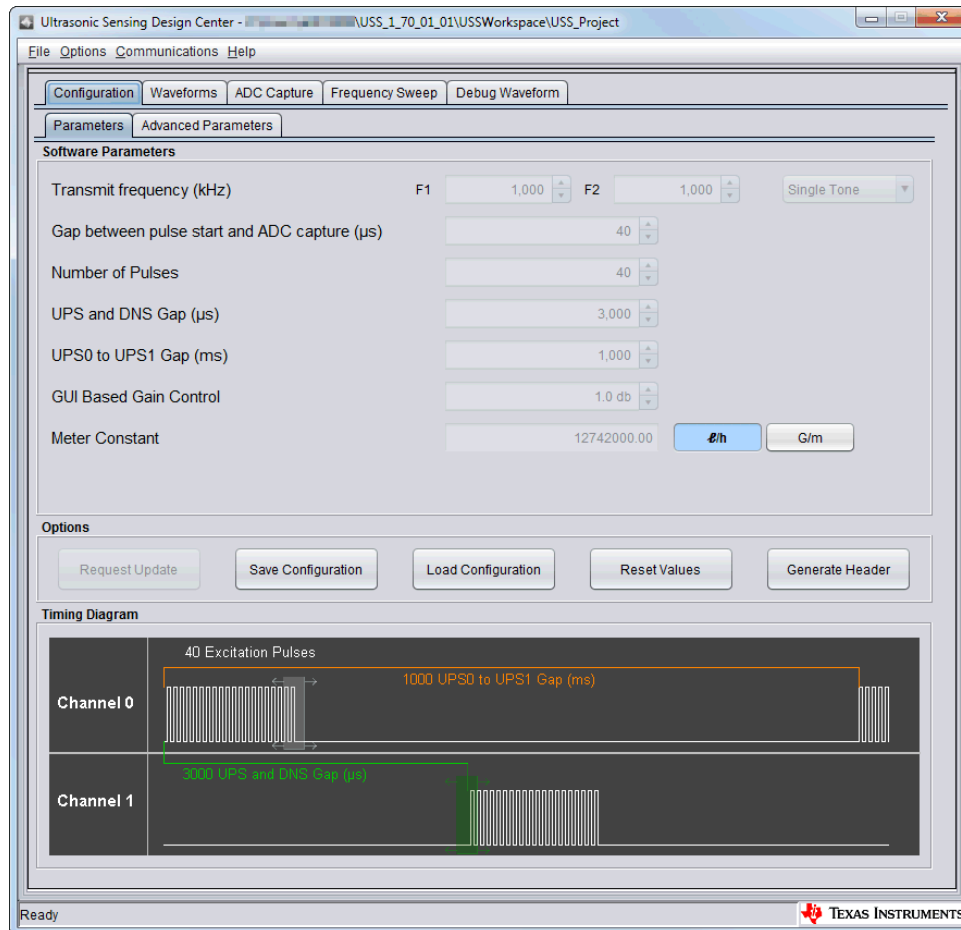

Figure 3. Design Center in Disconnected State

- To connect to the EVM, click **Communications** → **Connect** or press F1.
If the connection is successful, the Design Center reports the connection and detects the ID of the EVM430-FR6043 (see [Figure 4](#)).

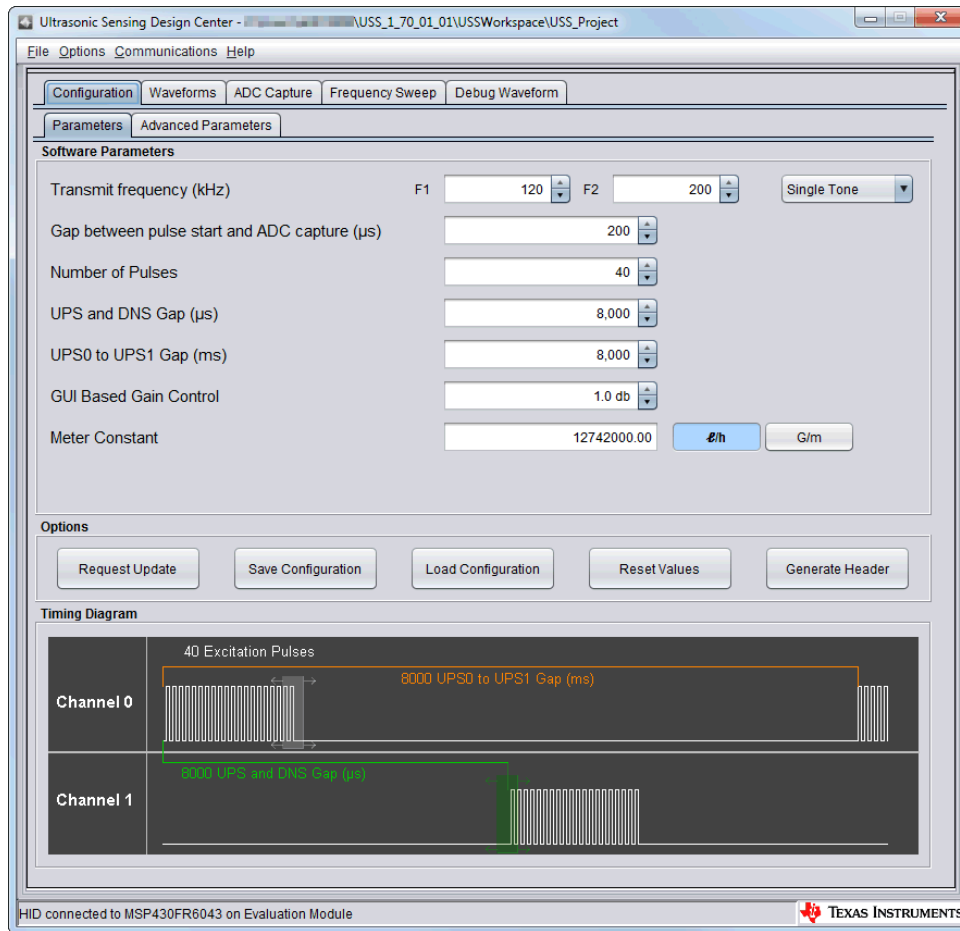

Figure 4. Design Center in Connected State

- Click **Load Configuration**, go to the `mtr_gui_config` in the *Ultrasonic Gas Demo Application for MSP430FR6043*, and select one of the example configurations.

The default folder is:

C:\ti\msp\<Ultrasonic_Gas_Demo_application_version>\examples\mtr_gui_config

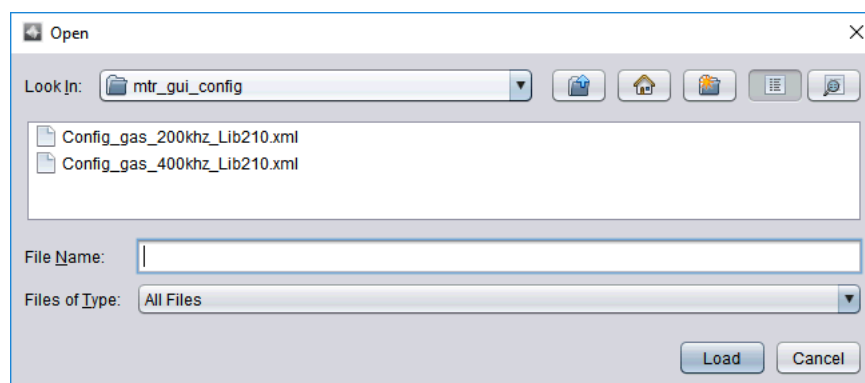

Figure 5. Loading a Configuration

- Click **Request Update**. The Design Center shows a message to indicate a successful update.

9. Select the ADC Capture window and click **Capture**. Design Center requests and plots an ADC capture of the ultrasonic signals (see [Figure 6](#)).

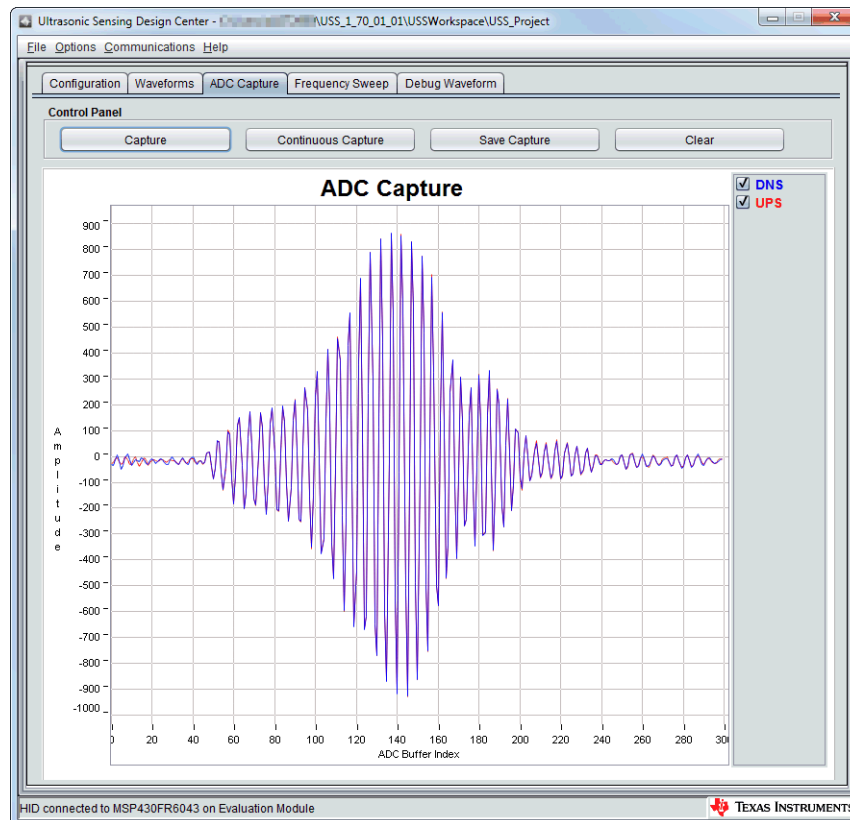

Figure 6. ADC Capture in Design Center

NOTE: The ADC waveform might be different from [Figure 6](#), but it should have sufficient amplitude, the upstream and downstream should look almost identical (without flow), and the complete signals should fit in the capture window.

For debugging information, see [Section 7](#).

10. Select the Waveforms tab and click **Start**. The Design Center plots the data received from the device (see Figure 7).



Figure 7. Waveforms in Design Center

NOTE: For information about debugging the waveforms, see [Section 7](#).

11. For other features and configuration of Design GUI, see the [MSP430FR6043 Ultrasonic Sensing Design Center User's Guide](#).

5 Customizing the Demo

The *Ultrasonic Gas Demo Application for MSP430FR6043* can be used to connect with different transducers and pipes by following the next steps:

1. Follow Steps 1 to 6 in [Section 4](#) to connect the EVM430-FR6043 to the Ultrasonic Sensing Design Center.
2. Load a default configuration in `mtr_gui_config` as a starting point to test the new transducers.
3. Send the configuration to the device.

4. Attempt to take an ADC capture.

The ADC Capture might be incorrect due to factors such as propagation time, transducer frequency, and gain (see [Figure 8](#)).

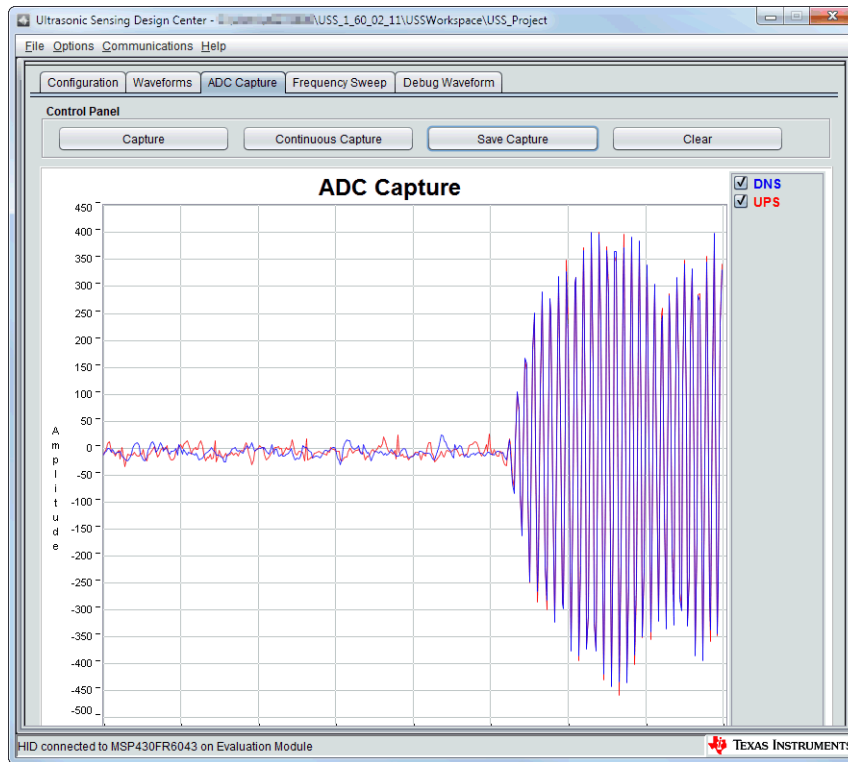

Figure 8. Incorrect ADC Capture

5. It is possible to modify some of the parameters based on a visual inspection of the waveform, or an oscilloscope can be used to observe and adjust the signals. Connect an oscilloscope to one of the transducer terminals and to the ADC input (see [Figure 9](#)).

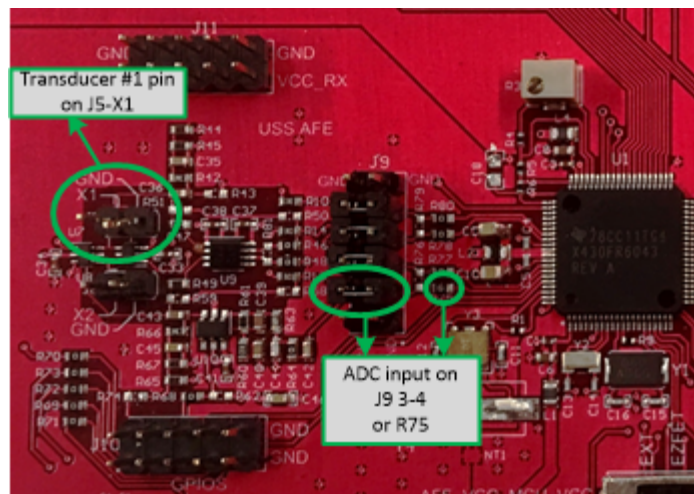

Figure 9. Oscilloscope Connections for EVM430-FR6043-E2

6. Observe the signal in the oscilloscope. **Figure 10** shows that it takes approximately 305 μs for the signal to arrive to the ADC input (in blue). Because of this, the signal is not received completely.

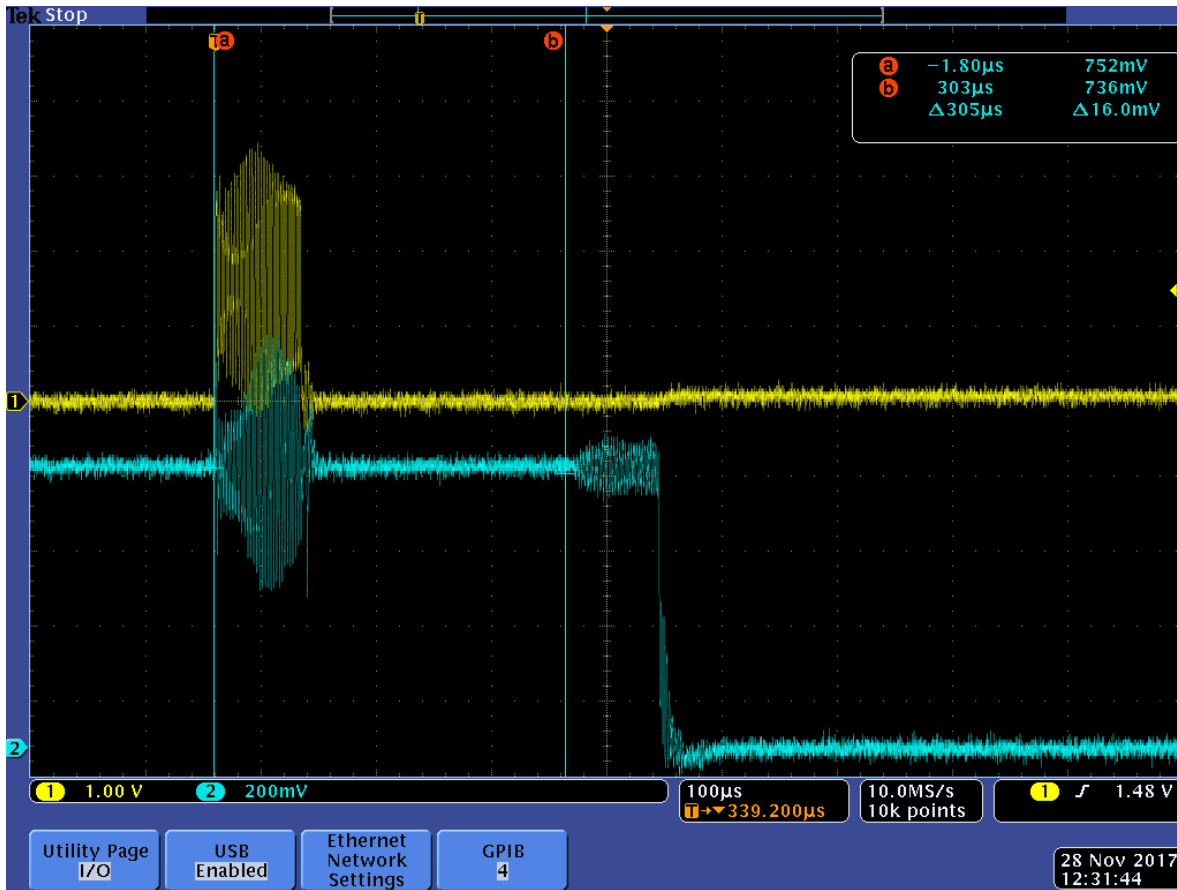

Figure 10. Unadjusted Signal in Oscilloscope

7. Adjust the parameters as needed, some of the most common parameters follow:
 - a. As observed in **Figure 8** and **Figure 10**, the biggest problem with the current configuration is that the ADC capture is occurring too early. This parameter can be adjusted using the “Gap between pulse start and ADC capture”.

Gap between pulse start and ADC capture (μs)

- b. The transducer transmit frequency can be adjusted manually based on the parameters of the transducers; however, TI recommends running a Frequency Sweep to determine the optimal configuration of the device.

For more information, see the [MSP430FR6043 Ultrasonic Sensing Design Center User's Guide](#).

Transmit frequency (kHz) F1 F2 F1 to F2 Sweep

- c. The number of pulses affects the amplitude and shape of the waveform:

Number of Pulses

- d. The UPS and DNS gap adjusts the time between upstream and downstream captures. This parameter can be adjusted to ensure enough settling time for the signals.

UPS and DNS Gap (μs)

- e. The UPS0 to UPS1 gap adjusts the measurement rate. Adjust to increase or decrease the measurement rate as a tradeoff of power consumption.

UPS0 to UPS1 Gap (ms)

- f. The Gain control adjusts the gain or attenuation of the signal. Adjust this parameter to ensure proper signal amplitude.

GUI Based Gain Control

- g. The signal sampling frequency can be adjusted to increase or decrease the sampling rate as a tradeoff of power consumption. Ensure a sampling rate at least 3.5x the transducer frequency. The sampling rate is typically modified together with the ADC oversampling rate, since some combinations can result in an invalid PLL setting. For more information, see the MSP430FR6043 Ultrasonic Sensing Design Center User's Guide (SLAU755).

Signal Sampling Frequency (kHz)

ADC Over Sampling Rate

- h. The capture duration can be adjusted to ensure enough time to capture the signal, including drifts due to temperature or flow. This parameter will affect the total number of samples which is limited by the application, and it will also affect power consumption due to processing time.

Capture Duration (μs)

- 8. Update the configuration, check the signal and repeat adjustments as needed.

6 Flashing the Binaries

1. The EVM430-FR6043 must be connected to USB using the default configuration in [Section 2.1.1](#).
2. Install [MSP Flasher](#). The default folder depends on the version:
C:\ti\\
3. In a command prompt, go to the *Ultrasonic Gas Demo Application for MSP430FR6043 image* folder. The default folder is:
C:\ti\msp\\image
4. In a command prompt, run the following command:
C:\ti\\MSP430Flasher.exe -w <application_text_file> -v -g -z [VCC]

- MSP Flasher detects the EVM and programs the device (see [Figure 11](#)).

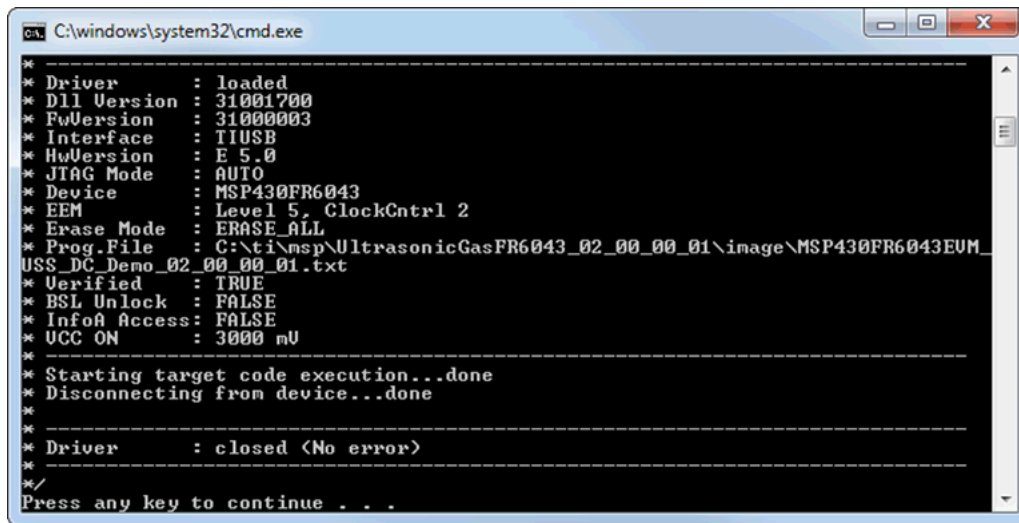

Figure 11. Successful Execution of MSP Flasher

For more information about [MSP Flasher](#), see the [MSP Flasher User's Guide](#).

7 Troubleshooting

1. Problem: The GUI doesn't recognize EVM.

Solutions:

- Make sure the EVM430-FR6043 is connected to PC.
- The EVM includes an HID bridge which should be recognized by Windows Device Manager as two HID devices:

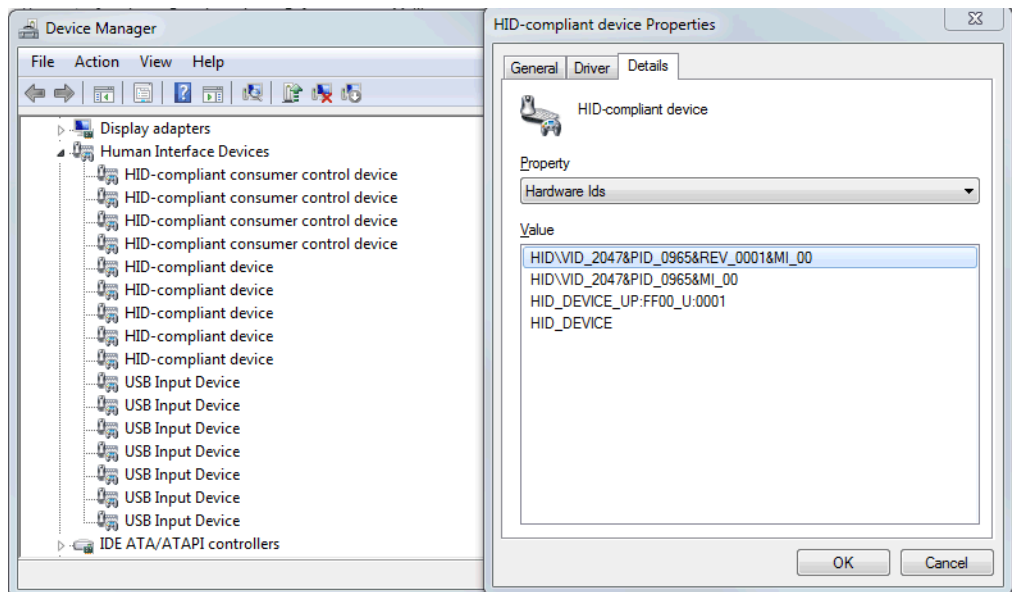

Figure 12. HID Bridge in Device Manager

- Make sure the jumpers are set properly to power the board and to communicate with the HID Bridge. Check the [EVM430-FR6043 hardware guide](#) for more details.
- Try restarting the GUI.
- If needed, reprogram the EVM as explained in [Section 6](#).

2. Problem: GUI is connected, but not updating device after loading a new configuration.

Solutions:

- Some configurations are not supported by the device. The GUI will display an error. Try with a different configuration, or modifying the firmware to support your custom configuration.
- Try re-flashing the device as described in [Section 6](#).

3. Problem: MSP Flasher, CCS or IAR cannot program and debug the EVM.

Solutions:

- Make sure EVM430-FR6043 is connected to PC.
- The EVM includes eZ-FET circuitry which is used to program and debug the MSP430FR6043. This device should be recognized by Windows Device Manager as two HID devices:

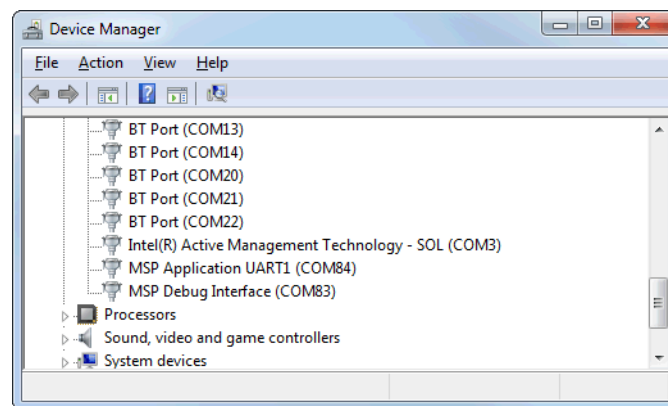

Figure 13. eZ-FET in Device Manager

- Drivers are needed for proper operation. TI recommends installing the drivers by installing an IDE such as TI CCS or IAR EW430. Drivers are also available from <http://www.ti.com/MSPdrivers>.
- Make sure the jumpers are set properly to power the board and to communicate with eZ-FET. See the [EVM430-FR6043 hardware guide](#) for more details.

4. Problem: ADC waveform looks incorrect.

Solutions:

- Verify the polarity of the transducers.
- Try adjusting the Design Center parameters as described in [Section 5](#).

5. Problem: Delta TOF (dTOF) and Volume Flow Rate data in the waveform window look noisy.

Solutions:

- The GUI adjusts the zoom automatically depending on the input. If the dTOF is not varying much, the signal will look noisy even though the change is minimal. Try changing the air flow rate to observe a more noticeable change.
- Gas meters are usually placed inside a shielded case to reduce noise. In such case, connect the GND shield to the EVM430-FR6043 ground using a connector such as J31 for revision E1 of the EVM, or TP2 for revision E2.
- A USB cable with ferrite can help reduce noise when connected to PC.
- A clean power supply can help reduce noise.

6. Problem: There is variation on dTOF and Volume Flow Rate even without flow.

Solutions:

- Zero-flow-drift (ZFD) tests are typically performed to observe the expected variation of the system and determine the minimum detectable flow. These tests require the meter to be sealed to reduce air flow to the minimum possible.
- Gas meters are usually placed inside a shielded case to reduce noise. In such case, connect the GND shield to the EVM430-FR6043 ground using a connector such as J31 for revision E1 of the EVM, or TP2 for revision E2.
- A USB cable with ferrite can help reduce noise when connected to PC.
- A clean power supply can help reduce noise.

7. Additional comments or questions?

- Submit comments or questions to the TI [E2E™](#) community forums.
- Configuration files, ADC captures (single and continuous), and waveform captures help to determine issues with the EVM, software, or Design Center.

8 References

1. [MSP430FR6043 ultrasonic sensing design center user's guide](#)
2. [EVM430-FR6043 hardware guide](#)

9 REACH Compliance

In compliance with the Article 33 provision of the EU REACH regulation, TI notifies you that this EVM includes components containing at least one Substance of Very High Concern (SVHC) above 0.1%. These uses from Texas Instruments do not exceed 1 ton per year. The SVHCs are:

Component Manufacturer	Component Part Number	SVHC Substance	SVHC CAS
Murata	CSTCR4M00G15L99-R0	Lead Titanium Zirconium Oxide	12626-81-2
Murata	CSTCR6M00G53Z-R0	Lead Titanium Zirconium Oxide	12626-81-2
Abracon	ABM3-8.000MHZ-D2Y-T	Diboron Trioxide	1303-86-2
Abracon	ABM3-8.000MHZ-D2Y-T	Lead Oxide	1317-36-8
Abracon	AWSCR-8.00CV-T	Boric Acid	10043-35-3
Abracon	AWSCR-8.00CV-T	Lead Oxide	1317-36-8

Revision History

NOTE: Page numbers for previous revisions may differ from page numbers in the current version.

Changes from July 19, 2018 to January 24, 2019	Page
• Removed references to the EVM430-FR6043-E1 revision throughout document.....	2
• Changed Figure 2 , <i>EVM430-FR6043 Connected to Gas-Flow Meter</i>	4
• Removed former Section 2.3 <i>Fan With Pipe Connector</i>	5
• Updated Section 8 , <i>References</i>	15

STANDARD TERMS FOR EVALUATION MODULES

1. *Delivery:* TI delivers TI evaluation boards, kits, or modules, including any accompanying demonstration software, components, and/or documentation which may be provided together or separately (collectively, an "EVM" or "EVMs") to the User ("User") in accordance with the terms set forth herein. User's acceptance of the EVM is expressly subject to the following terms.
 - 1.1 EVMs are intended solely for product or software developers for use in a research and development setting to facilitate feasibility evaluation, experimentation, or scientific analysis of TI semiconductors products. EVMs have no direct function and are not finished products. EVMs shall not be directly or indirectly assembled as a part or subassembly in any finished product. For clarification, any software or software tools provided with the EVM ("Software") shall not be subject to the terms and conditions set forth herein but rather shall be subject to the applicable terms that accompany such Software
 - 1.2 EVMs are not intended for consumer or household use. EVMs may not be sold, sublicensed, leased, rented, loaned, assigned, or otherwise distributed for commercial purposes by Users, in whole or in part, or used in any finished product or production system.
2. *Limited Warranty and Related Remedies/Disclaimers:*
 - 2.1 These terms do not apply to Software. The warranty, if any, for Software is covered in the applicable Software License Agreement.
 - 2.2 TI warrants that the TI EVM will conform to TI's published specifications for ninety (90) days after the date TI delivers such EVM to User. Notwithstanding the foregoing, TI shall not be liable for a nonconforming EVM if (a) the nonconformity was caused by neglect, misuse or mistreatment by an entity other than TI, including improper installation or testing, or for any EVMs that have been altered or modified in any way by an entity other than TI, (b) the nonconformity resulted from User's design, specifications or instructions for such EVMs or improper system design, or (c) User has not paid on time. Testing and other quality control techniques are used to the extent TI deems necessary. TI does not test all parameters of each EVM. User's claims against TI under this Section 2 are void if User fails to notify TI of any apparent defects in the EVMs within ten (10) business days after delivery, or of any hidden defects with ten (10) business days after the defect has been detected.
 - 2.3 TI's sole liability shall be at its option to repair or replace EVMs that fail to conform to the warranty set forth above, or credit User's account for such EVM. TI's liability under this warranty shall be limited to EVMs that are returned during the warranty period to the address designated by TI and that are determined by TI not to conform to such warranty. If TI elects to repair or replace such EVM, TI shall have a reasonable time to repair such EVM or provide replacements. Repaired EVMs shall be warranted for the remainder of the original warranty period. Replaced EVMs shall be warranted for a new full ninety (90) day warranty period.

WARNING

Evaluation Kits are intended solely for use by technically qualified, professional electronics experts who are familiar with the dangers and application risks associated with handling electrical mechanical components, systems, and subsystems.

User shall operate the Evaluation Kit within TI's recommended guidelines and any applicable legal or environmental requirements as well as reasonable and customary safeguards. Failure to set up and/or operate the Evaluation Kit within TI's recommended guidelines may result in personal injury or death or property damage. Proper set up entails following TI's instructions for electrical ratings of interface circuits such as input, output and electrical loads.

NOTE:

EXPOSURE TO ELECTROSTATIC DISCHARGE (ESD) MAY CAUSE DEGRADATION OR FAILURE OF THE EVALUATION KIT; TI RECOMMENDS STORAGE OF THE EVALUATION KIT IN A PROTECTIVE ESD BAG.

3 Regulatory Notices:

3.1 United States

3.1.1 Notice applicable to EVMs not FCC-Approved:

FCC NOTICE: This kit is designed to allow product developers to evaluate electronic components, circuitry, or software associated with the kit to determine whether to incorporate such items in a finished product and software developers to write software applications for use with the end product. This kit is not a finished product and when assembled may not be resold or otherwise marketed unless all required FCC equipment authorizations are first obtained. Operation is subject to the condition that this product not cause harmful interference to licensed radio stations and that this product accept harmful interference. Unless the assembled kit is designed to operate under part 15, part 18 or part 95 of this chapter, the operator of the kit must operate under the authority of an FCC license holder or must secure an experimental authorization under part 5 of this chapter.

3.1.2 For EVMs annotated as FCC – FEDERAL COMMUNICATIONS COMMISSION Part 15 Compliant:

CAUTION

This device complies with part 15 of the FCC Rules. Operation is subject to the following two conditions: (1) This device may not cause harmful interference, and (2) this device must accept any interference received, including interference that may cause undesired operation.

Changes or modifications not expressly approved by the party responsible for compliance could void the user's authority to operate the equipment.

FCC Interference Statement for Class A EVM devices

NOTE: This equipment has been tested and found to comply with the limits for a Class A digital device, pursuant to part 15 of the FCC Rules. These limits are designed to provide reasonable protection against harmful interference when the equipment is operated in a commercial environment. This equipment generates, uses, and can radiate radio frequency energy and, if not installed and used in accordance with the instruction manual, may cause harmful interference to radio communications. Operation of this equipment in a residential area is likely to cause harmful interference in which case the user will be required to correct the interference at his own expense.

FCC Interference Statement for Class B EVM devices

NOTE: This equipment has been tested and found to comply with the limits for a Class B digital device, pursuant to part 15 of the FCC Rules. These limits are designed to provide reasonable protection against harmful interference in a residential installation. This equipment generates, uses and can radiate radio frequency energy and, if not installed and used in accordance with the instructions, may cause harmful interference to radio communications. However, there is no guarantee that interference will not occur in a particular installation. If this equipment does cause harmful interference to radio or television reception, which can be determined by turning the equipment off and on, the user is encouraged to try to correct the interference by one or more of the following measures:

- Reorient or relocate the receiving antenna.
- Increase the separation between the equipment and receiver.
- Connect the equipment into an outlet on a circuit different from that to which the receiver is connected.
- Consult the dealer or an experienced radio/TV technician for help.

3.2 Canada

3.2.1 For EVMs issued with an Industry Canada Certificate of Conformance to RSS-210 or RSS-247

Concerning EVMs Including Radio Transmitters:

This device complies with Industry Canada license-exempt RSSs. Operation is subject to the following two conditions:

(1) this device may not cause interference, and (2) this device must accept any interference, including interference that may cause undesired operation of the device.

Concernant les EVMs avec appareils radio:

Le présent appareil est conforme aux CNR d'Industrie Canada applicables aux appareils radio exempts de licence. L'exploitation est autorisée aux deux conditions suivantes: (1) l'appareil ne doit pas produire de brouillage, et (2) l'utilisateur de l'appareil doit accepter tout brouillage radioélectrique subi, même si le brouillage est susceptible d'en compromettre le fonctionnement.

Concerning EVMs Including Detachable Antennas:

Under Industry Canada regulations, this radio transmitter may only operate using an antenna of a type and maximum (or lesser) gain approved for the transmitter by Industry Canada. To reduce potential radio interference to other users, the antenna type and its gain should be so chosen that the equivalent isotropically radiated power (e.i.r.p.) is not more than that necessary for successful communication. This radio transmitter has been approved by Industry Canada to operate with the antenna types listed in the user guide with the maximum permissible gain and required antenna impedance for each antenna type indicated. Antenna types not included in this list, having a gain greater than the maximum gain indicated for that type, are strictly prohibited for use with this device.

Concernant les EVMs avec antennes détachables

Conformément à la réglementation d'Industrie Canada, le présent émetteur radio peut fonctionner avec une antenne d'un type et d'un gain maximal (ou inférieur) approuvé pour l'émetteur par Industrie Canada. Dans le but de réduire les risques de brouillage radioélectrique à l'intention des autres utilisateurs, il faut choisir le type d'antenne et son gain de sorte que la puissance isotrope rayonnée équivalente (p.i.r.e.) ne dépasse pas l'intensité nécessaire à l'établissement d'une communication satisfaisante. Le présent émetteur radio a été approuvé par Industrie Canada pour fonctionner avec les types d'antenne énumérés dans le manuel d'usage et ayant un gain admissible maximal et l'impédance requise pour chaque type d'antenne. Les types d'antenne non inclus dans cette liste, ou dont le gain est supérieur au gain maximal indiqué, sont strictement interdits pour l'exploitation de l'émetteur.

3.3 Japan

3.3.1 *Notice for EVMs delivered in Japan:* Please see http://www.tij.co.jp/lstds/ti_ja/general/eStore/notice_01.page 日本国内に輸入される評価用キット、ボードについては、次のところをご覧ください。
http://www.tij.co.jp/lstds/ti_ja/general/eStore/notice_01.page

3.3.2 *Notice for Users of EVMs Considered "Radio Frequency Products" in Japan:* EVMs entering Japan may not be certified by TI as conforming to Technical Regulations of Radio Law of Japan.

If User uses EVMs in Japan, not certified to Technical Regulations of Radio Law of Japan, User is required to follow the instructions set forth by Radio Law of Japan, which includes, but is not limited to, the instructions below with respect to EVMs (which for the avoidance of doubt are stated strictly for convenience and should be verified by User):

1. Use EVMs in a shielded room or any other test facility as defined in the notification #173 issued by Ministry of Internal Affairs and Communications on March 28, 2006, based on Sub-section 1.1 of Article 6 of the Ministry's Rule for Enforcement of Radio Law of Japan,
2. Use EVMs only after User obtains the license of Test Radio Station as provided in Radio Law of Japan with respect to EVMs, or
3. Use of EVMs only after User obtains the Technical Regulations Conformity Certification as provided in Radio Law of Japan with respect to EVMs. Also, do not transfer EVMs, unless User gives the same notice above to the transferee. Please note that if User does not follow the instructions above, User will be subject to penalties of Radio Law of Japan.

【無線電波を送信する製品の開発キットをお使いになる際の注意事項】 開発キットの中には技術基準適合証明を受けていないものがあります。技術適合証明を受けていないものご使用に際しては、電波法遵守のため、以下のいずれかの措置を取っていただく必要がありますのでご注意ください。

1. 電波法施行規則第6条第1項第1号に基づく平成18年3月28日総務省告示第173号で定められた電波暗室等の試験設備でご使用いただく。
2. 実験局の免許を取得後ご使用いただく。
3. 技術基準適合証明を取得後ご使用いただく。

なお、本製品は、上記の「ご使用にあたっての注意」を譲渡先、移転先に通知しない限り、譲渡、移転できないものとします。

上記を遵守頂けない場合は、電波法の罰則が適用される可能性があることをご留意ください。日本テキサス・インスツルメンツ株式会社
東京都新宿区西新宿 6 丁目 2 4 番 1 号
西新宿三井ビル

3.3.3 *Notice for EVMs for Power Line Communication:* Please see http://www.tij.co.jp/lstds/ti_ja/general/eStore/notice_02.page
電力線搬送波通信についての開発キットをお使いになる際の注意事項については、次のところをご覧ください。http://www.tij.co.jp/lstds/ti_ja/general/eStore/notice_02.page

3.4 European Union

3.4.1 *For EVMs subject to EU Directive 2014/30/EU (Electromagnetic Compatibility Directive):*

This is a class A product intended for use in environments other than domestic environments that are connected to a low-voltage power-supply network that supplies buildings used for domestic purposes. In a domestic environment this product may cause radio interference in which case the user may be required to take adequate measures.

-
- 4 *EVM Use Restrictions and Warnings:*
 - 4.1 EVMS ARE NOT FOR USE IN FUNCTIONAL SAFETY AND/OR SAFETY CRITICAL EVALUATIONS, INCLUDING BUT NOT LIMITED TO EVALUATIONS OF LIFE SUPPORT APPLICATIONS.
 - 4.2 User must read and apply the user guide and other available documentation provided by TI regarding the EVM prior to handling or using the EVM, including without limitation any warning or restriction notices. The notices contain important safety information related to, for example, temperatures and voltages.
 - 4.3 *Safety-Related Warnings and Restrictions:*
 - 4.3.1 User shall operate the EVM within TI's recommended specifications and environmental considerations stated in the user guide, other available documentation provided by TI, and any other applicable requirements and employ reasonable and customary safeguards. Exceeding the specified performance ratings and specifications (including but not limited to input and output voltage, current, power, and environmental ranges) for the EVM may cause personal injury or death, or property damage. If there are questions concerning performance ratings and specifications, User should contact a TI field representative prior to connecting interface electronics including input power and intended loads. Any loads applied outside of the specified output range may also result in unintended and/or inaccurate operation and/or possible permanent damage to the EVM and/or interface electronics. Please consult the EVM user guide prior to connecting any load to the EVM output. If there is uncertainty as to the load specification, please contact a TI field representative. During normal operation, even with the inputs and outputs kept within the specified allowable ranges, some circuit components may have elevated case temperatures. These components include but are not limited to linear regulators, switching transistors, pass transistors, current sense resistors, and heat sinks, which can be identified using the information in the associated documentation. When working with the EVM, please be aware that the EVM may become very warm.
 - 4.3.2 EVMs are intended solely for use by technically qualified, professional electronics experts who are familiar with the dangers and application risks associated with handling electrical mechanical components, systems, and subsystems. User assumes all responsibility and liability for proper and safe handling and use of the EVM by User or its employees, affiliates, contractors or designees. User assumes all responsibility and liability to ensure that any interfaces (electronic and/or mechanical) between the EVM and any human body are designed with suitable isolation and means to safely limit accessible leakage currents to minimize the risk of electrical shock hazard. User assumes all responsibility and liability for any improper or unsafe handling or use of the EVM by User or its employees, affiliates, contractors or designees.
 - 4.4 User assumes all responsibility and liability to determine whether the EVM is subject to any applicable international, federal, state, or local laws and regulations related to User's handling and use of the EVM and, if applicable, User assumes all responsibility and liability for compliance in all respects with such laws and regulations. User assumes all responsibility and liability for proper disposal and recycling of the EVM consistent with all applicable international, federal, state, and local requirements.
 5. *Accuracy of Information:* To the extent TI provides information on the availability and function of EVMs, TI attempts to be as accurate as possible. However, TI does not warrant the accuracy of EVM descriptions, EVM availability or other information on its websites as accurate, complete, reliable, current, or error-free.
 6. *Disclaimers:*
 - 6.1 EXCEPT AS SET FORTH ABOVE, EVMS AND ANY MATERIALS PROVIDED WITH THE EVM (INCLUDING, BUT NOT LIMITED TO, REFERENCE DESIGNS AND THE DESIGN OF THE EVM ITSELF) ARE PROVIDED "AS IS" AND "WITH ALL FAULTS." TI DISCLAIMS ALL OTHER WARRANTIES, EXPRESS OR IMPLIED, REGARDING SUCH ITEMS, INCLUDING BUT NOT LIMITED TO ANY EPIDEMIC FAILURE WARRANTY OR IMPLIED WARRANTIES OF MERCHANTABILITY OR FITNESS FOR A PARTICULAR PURPOSE OR NON-INFRINGEMENT OF ANY THIRD PARTY PATENTS, COPYRIGHTS, TRADE SECRETS OR OTHER INTELLECTUAL PROPERTY RIGHTS.
 - 6.2 EXCEPT FOR THE LIMITED RIGHT TO USE THE EVM SET FORTH HEREIN, NOTHING IN THESE TERMS SHALL BE CONSTRUED AS GRANTING OR CONFERRING ANY RIGHTS BY LICENSE, PATENT, OR ANY OTHER INDUSTRIAL OR INTELLECTUAL PROPERTY RIGHT OF TI, ITS SUPPLIERS/LICENSORS OR ANY OTHER THIRD PARTY, TO USE THE EVM IN ANY FINISHED END-USER OR READY-TO-USE FINAL PRODUCT, OR FOR ANY INVENTION, DISCOVERY OR IMPROVEMENT, REGARDLESS OF WHEN MADE, CONCEIVED OR ACQUIRED.
 7. *USER'S INDEMNITY OBLIGATIONS AND REPRESENTATIONS.* USER WILL DEFEND, INDEMNIFY AND HOLD TI, ITS LICENSORS AND THEIR REPRESENTATIVES HARMLESS FROM AND AGAINST ANY AND ALL CLAIMS, DAMAGES, LOSSES, EXPENSES, COSTS AND LIABILITIES (COLLECTIVELY, "CLAIMS") ARISING OUT OF OR IN CONNECTION WITH ANY HANDLING OR USE OF THE EVM THAT IS NOT IN ACCORDANCE WITH THESE TERMS. THIS OBLIGATION SHALL APPLY WHETHER CLAIMS ARISE UNDER STATUTE, REGULATION, OR THE LAW OF TORT, CONTRACT OR ANY OTHER LEGAL THEORY, AND EVEN IF THE EVM FAILS TO PERFORM AS DESCRIBED OR EXPECTED.

8. *Limitations on Damages and Liability:*

8.1 *General Limitations.* IN NO EVENT SHALL TI BE LIABLE FOR ANY SPECIAL, COLLATERAL, INDIRECT, PUNITIVE, INCIDENTAL, CONSEQUENTIAL, OR EXEMPLARY DAMAGES IN CONNECTION WITH OR ARISING OUT OF THESE TERMS OR THE USE OF THE EVMS , REGARDLESS OF WHETHER TI HAS BEEN ADVISED OF THE POSSIBILITY OF SUCH DAMAGES. EXCLUDED DAMAGES INCLUDE, BUT ARE NOT LIMITED TO, COST OF REMOVAL OR REINSTALLATION, ANCILLARY COSTS TO THE PROCUREMENT OF SUBSTITUTE GOODS OR SERVICES, RETESTING, OUTSIDE COMPUTER TIME, LABOR COSTS, LOSS OF GOODWILL, LOSS OF PROFITS, LOSS OF SAVINGS, LOSS OF USE, LOSS OF DATA, OR BUSINESS INTERRUPTION. NO CLAIM, SUIT OR ACTION SHALL BE BROUGHT AGAINST TI MORE THAN TWELVE (12) MONTHS AFTER THE EVENT THAT GAVE RISE TO THE CAUSE OF ACTION HAS OCCURRED.

8.2 *Specific Limitations.* IN NO EVENT SHALL TI'S AGGREGATE LIABILITY FROM ANY USE OF AN EVM PROVIDED HEREUNDER, INCLUDING FROM ANY WARRANTY, INDEMNITY OR OTHER OBLIGATION ARISING OUT OF OR IN CONNECTION WITH THESE TERMS, , EXCEED THE TOTAL AMOUNT PAID TO TI BY USER FOR THE PARTICULAR EVM(S) AT ISSUE DURING THE PRIOR TWELVE (12) MONTHS WITH RESPECT TO WHICH LOSSES OR DAMAGES ARE CLAIMED. THE EXISTENCE OF MORE THAN ONE CLAIM SHALL NOT ENLARGE OR EXTEND THIS LIMIT.

9. *Return Policy.* Except as otherwise provided, TI does not offer any refunds, returns, or exchanges. Furthermore, no return of EVM(s) will be accepted if the package has been opened and no return of the EVM(s) will be accepted if they are damaged or otherwise not in a resalable condition. If User feels it has been incorrectly charged for the EVM(s) it ordered or that delivery violates the applicable order, User should contact TI. All refunds will be made in full within thirty (30) working days from the return of the components(s), excluding any postage or packaging costs.

10. *Governing Law:* These terms and conditions shall be governed by and interpreted in accordance with the laws of the State of Texas, without reference to conflict-of-laws principles. User agrees that non-exclusive jurisdiction for any dispute arising out of or relating to these terms and conditions lies within courts located in the State of Texas and consents to venue in Dallas County, Texas. Notwithstanding the foregoing, any judgment may be enforced in any United States or foreign court, and TI may seek injunctive relief in any United States or foreign court.

Mailing Address: Texas Instruments, Post Office Box 655303, Dallas, Texas 75265
Copyright © 2019, Texas Instruments Incorporated

IMPORTANT NOTICE AND DISCLAIMER

TI PROVIDES TECHNICAL AND RELIABILITY DATA (INCLUDING DATASHEETS), DESIGN RESOURCES (INCLUDING REFERENCE DESIGNS), APPLICATION OR OTHER DESIGN ADVICE, WEB TOOLS, SAFETY INFORMATION, AND OTHER RESOURCES "AS IS" AND WITH ALL FAULTS, AND DISCLAIMS ALL WARRANTIES, EXPRESS AND IMPLIED, INCLUDING WITHOUT LIMITATION ANY IMPLIED WARRANTIES OF MERCHANTABILITY, FITNESS FOR A PARTICULAR PURPOSE OR NON-INFRINGEMENT OF THIRD PARTY INTELLECTUAL PROPERTY RIGHTS.

These resources are intended for skilled developers designing with TI products. You are solely responsible for (1) selecting the appropriate TI products for your application, (2) designing, validating and testing your application, and (3) ensuring your application meets applicable standards, and any other safety, security, or other requirements. These resources are subject to change without notice. TI grants you permission to use these resources only for development of an application that uses the TI products described in the resource. Other reproduction and display of these resources is prohibited. No license is granted to any other TI intellectual property right or to any third party intellectual property right. TI disclaims responsibility for, and you will fully indemnify TI and its representatives against, any claims, damages, costs, losses, and liabilities arising out of your use of these resources.

TI's products are provided subject to TI's Terms of Sale (www.ti.com/legal/termsofsale.html) or other applicable terms available either on ti.com or provided in conjunction with such TI products. TI's provision of these resources does not expand or otherwise alter TI's applicable warranties or warranty disclaimers for TI products.

Mailing Address: Texas Instruments, Post Office Box 655303, Dallas, Texas 75265
Copyright © 2019, Texas Instruments Incorporated